















Guidelines and Instructions		Page
<a href="#">Type code</a>	Type code of transmitters	2
<a href="#">Installation</a>	Selection and installation of transmitters for WEKA Visual Level Indicators	3
<a href="#">Datasheet 20010501</a>	Installation Instructions (Datasheet 20010501)	4
<a href="#">Bi-stable reed</a>	General information about bi-stable reed-switch type level transmitters	5

WEKA transmitters: Resistant output or current supplied voltage output (3-wire)			
Transmitter	Media temperature	Connection	
<a href="#">29710</a>	-50°C ... +150°C	Cable, shielded	6
<a href="#">29710-W</a>	-50°C ... +350°C	Cable	7

WEKA transmitters: Current output 4...20mA (2-wire)			
Transmitter	Media temperature	Connection	
<a href="#">31967</a>	-50°C ... +150°C	Cable, shielded	8
<a href="#">31967-W</a>	-50°C ... +250°C	Cable, halogen-free 	9
<a href="#">31967-K</a>	-50°C ... +150°C	Terminal box	10
<a href="#">31967-KST</a>	-50°C ... +150°C	Plug-in connector	11

WEKA transmitters for hazardous areas: Intrinsically safe (Ex i)			
Resistant output, current supplied voltage output (3-wire) or current output 4...20mA (2-wire)			
Transmitter	Media temperature	Connection	Marking
<a href="#">29710-NI</a> 	-50°C ... +150°C	Cable, halogen-free 	II 2 G Ex ia IIC T4 Gb II 2 D Ex ia IIIC T115°C
<a href="#">32607-NI</a> 	-50°C ... +150°C	Cable, halogen-free 	II 2 G Ex ia IIC T4 Gb II 2 D Ex ia IIIC T115°C

WEKA transmitters for hazardous areas: Flameproof enclosures (Ex d)			
Resistant output, current supplied voltage output (3-wire) or current output 4...20mA (2-wire)			
Transmitter	Media temperature	Connection	Marking
<a href="#">29710-ND</a> 	-50°C ... +150°C	Cable, halogen-free 	II 2 G Ex db IIC T6 Gb II 2 D Ex tb IIIC T85°C Db
<a href="#">32608-ND</a> 	-50°C ... +150°C	Cable, halogen-free 	II 2 G Ex db IIC T6 Gb II 2 D Ex tb IIIC T85°C Db

WEKA transmitters for use with HART®, Profibus PA® or Foundation Fieldbus™ converter module interface					
4...20mA current output or resistance output					
<b>WEKA transmitters with resistance output or current supplied voltage output</b>					
Transmitter	Media temperature	Connection	Protection class	Certificate	
<a href="#">29710-R</a>	-50°C ... +150°C	Cable, shielded	Non-hazardous	-	20
<a href="#">29710-R-NI</a> 	-50°C ... +150°C	Cable, halogen-free 	Ex i	see 29710-NI	21
<a href="#">29710-R-W</a>	-50°C ... +350°C	Cable	Non-hazardous	-	22
<a href="#">29710-R-ND</a> 	-50°C ... +150°C	Cable, halogen-free 	Ex d	see 29710-ND	23
Differenz to 29710, 29710-NI, 29710-W and 29710_ND is only the entended measuring length Mel.					
<b>4...20mA converter with diagnostic functions, ready to connect, mounted in junction box</b>					
Converter	Description	Compatible transmitters			
<a href="#">SC-10 45755</a>	4...20mA converter in IP65 metal enclosure	29710-xx			24
<b>HART® converter, ready to connect, mounted in junction box</b>					
Converter	Description	Compatible transmitters			
<a href="#">HART 37383</a>	HART® converter in IP65 metal enclosure	29710-R and 29710-R-W			25
<a href="#">HART 40038</a>	HART® converter in IP65 metal enclosure with digital display	29710-R and 29710-R-W			26
<a href="#">HART 37384</a> 	HART® converter - Intrinsically safe	29710-R-NI and 29710-R-W			27
<a href="#">HART 38021</a> 	HART® converter - Flameproof enclosures	29710-R-ND			28
<b>Profibus PA® and Foundation Fieldbus™ converter, ready to connect, mounted in junction box</b>					
Converter	Description	Compatible transmitters			
<a href="#">PA+FF 40268</a>	Profibus PA® and FF™ converter in IP65 metal enclosure	29710-R and 29710-R-W			29

--	--	--	--	--	--

<a href="#">Ex-Info</a> 	Classification of hazardous zones and marking of equipment	30
<a href="#">Ex-5.7</a>	Extract of standard of simple electrical apparatus	31

Type code

	available for:	index:	
<b>Type of transmitter</b>			.....-.....-.....-010-.....
3-wire: resistant output or current supplied voltage output		29710	
2-wire: 4...20mA current output, current sink		31967	
2-wire: Intrinsically safe Ex ia; 4...20mA current output, current sink		32607	
2-wire: Flameproof enclosures Ex d, 4...20mA current output, current sink		32608	
<b>Specialities</b>			
Standard		no marking	
With resistant output for HART®, Profibus PA® and Foundation Fieldbus™	29710	R	
Transmitter with bi-stable reed switch at the top end	29710 / 31967	BI	
<b>Execution</b>			
Standard		no marking	
for high media temperature	29710 / 31967	W	
with terminal box	31967	K	
with plug connector	31967	KST	
Intrinsically safe Ex ia	29710 / 32607	NI	
Flameproof enclosures, Ex id	29710 / 32608	ND	
<b>Size of resistance</b>			
10 Ohm per step (not applicable for NI/ND)	all	010	
<b>Resolution</b>			
5mm	all	05	
10mm	all	10	

Level Indicator A-version

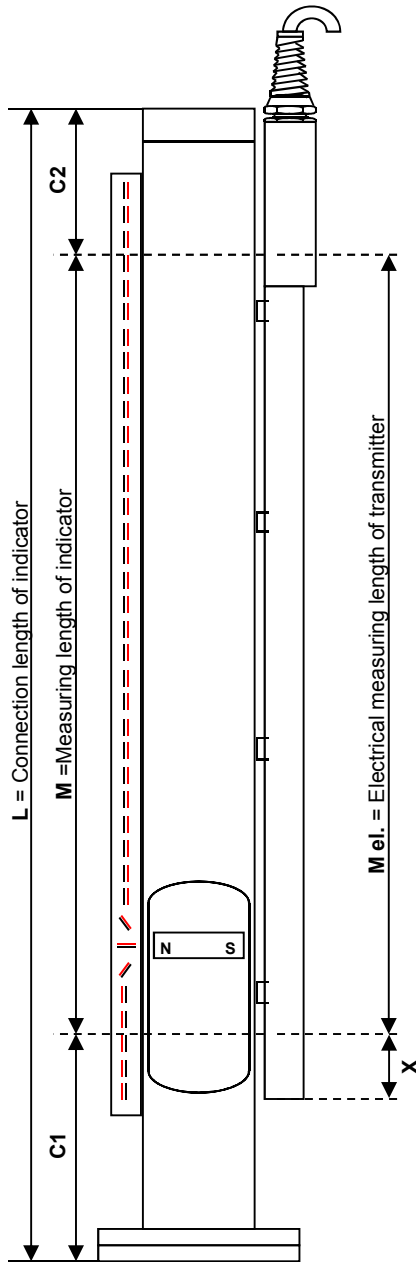

Level Indicator K-version

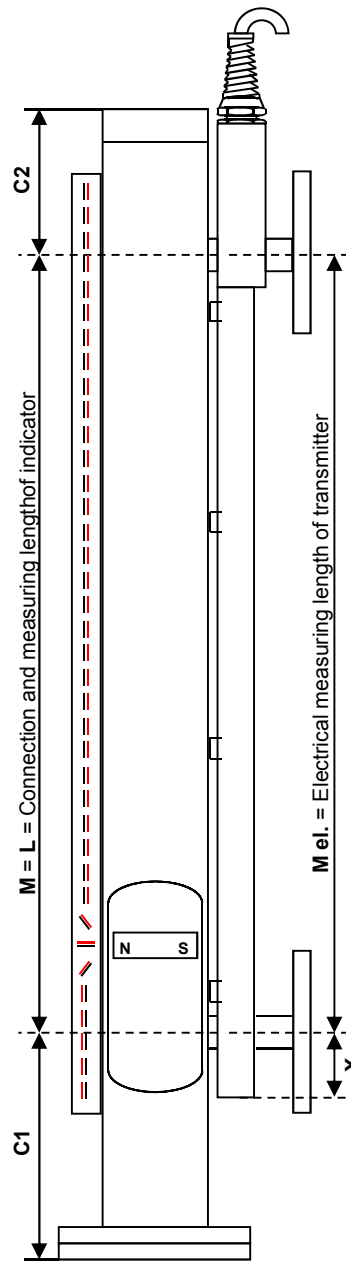

**Terminology:**

- L = Length between process connections
- M = Measuring length (indication length) of level indicator
- M el. = Measuring length of transmitter
- C1 = Bottom float extension
- C2 = Top float extension
- X = Initiating point of transmitter
  - 10 mm resolution -> X = 65 mm
  - 5 mm resolution -> X = 30 mm
  - 29710-R-xx version -> see datasheet

Visual level indicators version -A and -K are recommended for most applications.

Visual level indicators version -B and -O may require special dimensions and should be confirmed by WEKA before ordering.

**Transmitter length:**

Type -K and -O magnetic level indicators:  
 M el. = M = L or M el. = according to customer order (<M)

Type -A and -B magnetic level indicators:  
 M el. = M or M el. = according to customer order (<M)

**Note:**

When M el. < M, then a bi-stable reed switch is necessary.  
 For transmitters type 29710-R-x-010-xx M el. must be > M.

**Mounting**

**Normal:** Installation 180 °C opposite of the indication rail with the permitted tolerance according to the tube diameter (refer to layout below)  
Cable exit upwards.

**Variation:** Mounting the Transmitter adjacent to the indication rail except for Smartline.  
Cable exit upwards.

34000

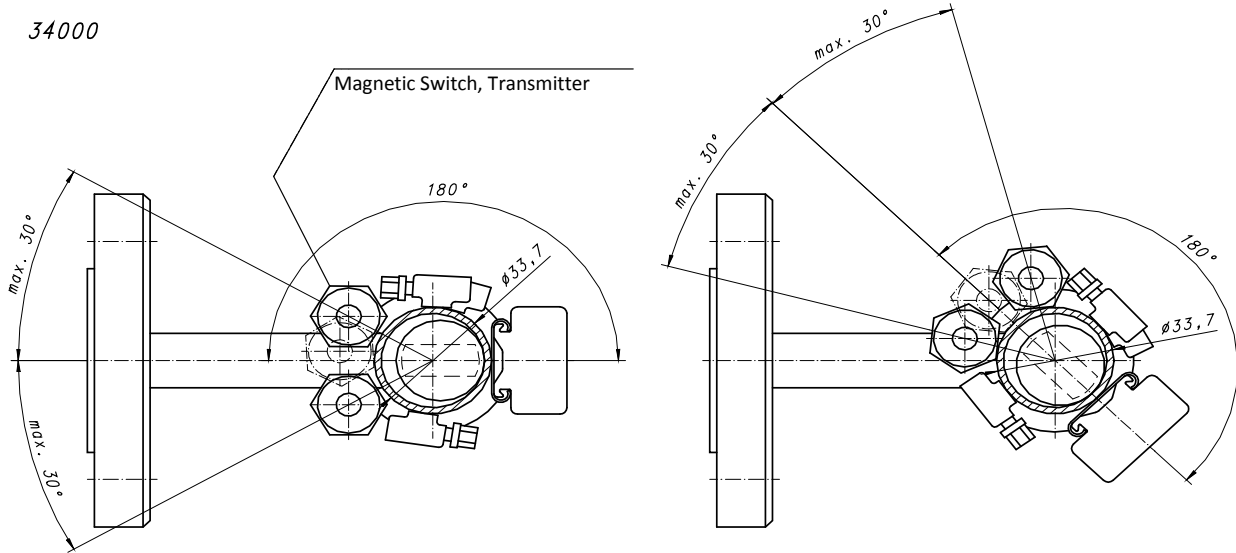

23614, 34300, 32755

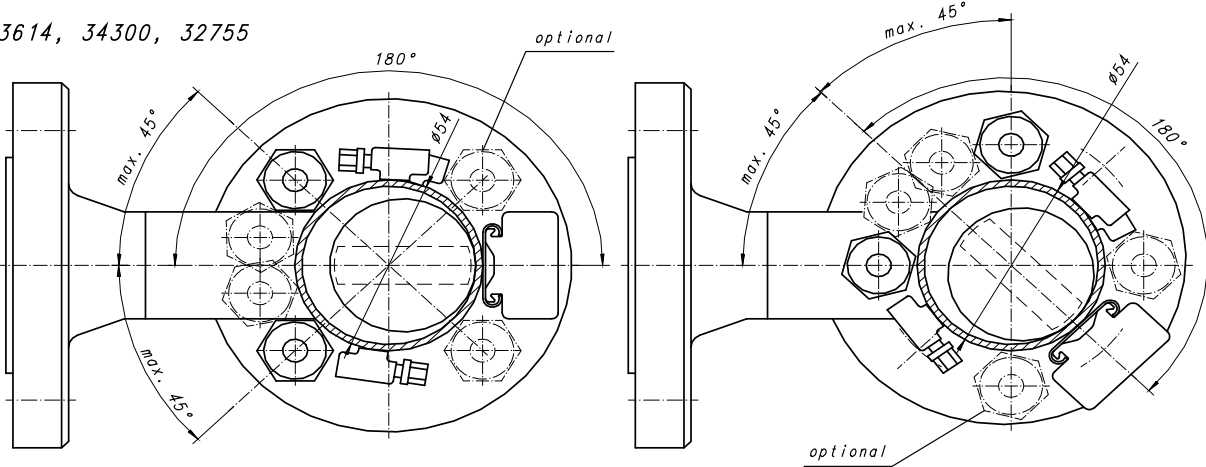

34110

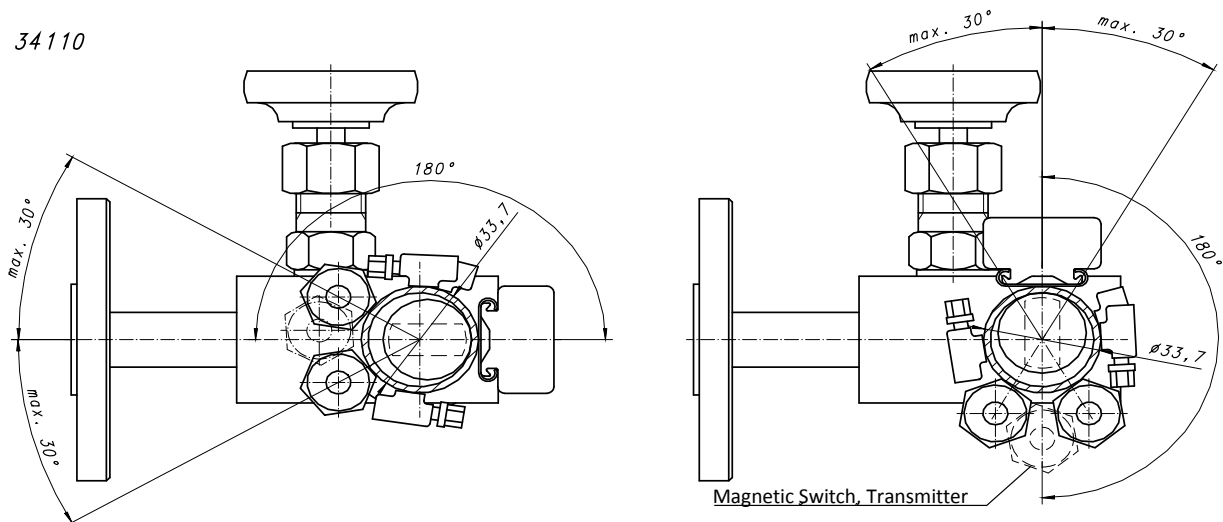

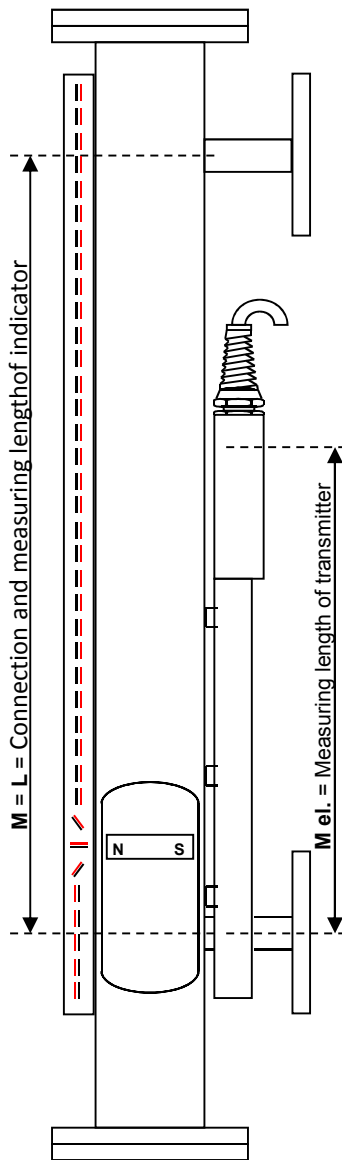

Figure 1

Identification

Type XXXXX-Bi-xx-010-xx

Example

31967-Bi-W-010-05

**Principles of operation:**

The permanent magnet inside the float activates the reed switches of the transmitter depending on the vertical position of the float. This results in an electrical signal output proportional to the level of liquid in the indicator's float chamber.

If the float rises above the transmitter's measuring range (M el.), the value of the electrical signal output will jump to 115% of the total measuring range. This over-limit value of the signal will remain constant for any level above the total measuring range (M el.). See figure 2.

Since the over-limit output signal represents a non-defined level, a second high-limit bi-stable reed switch can be fitted.

This bi-stable reed switch closes when the south pole of the float's magnet reaches the high-limit level and remains closed while the float is at any level above this limit. It opens again when the float drops below this limit again. See figure 2.

**Possible error condition:**

If the bi-stable reed switch is closed due to any other reasons such as during transport, or forced by an external magnetic field, the output signal will be incorrect. See Figure 3.

**Corrective actions:**

- Install the transmitter module 180° opposite to the indication rail. See Installation Instructions, datasheet 20010501.
- OR fill the vessel on which the level indicator is installed so that the float rises above the bi-stable reed switch. Empty the vessel, so the bi-stable reed switch is operated through one complete close-open cycle.
- OR pass a permanent bar magnet with its south pole pointing towards the transmitter downwards from top to bottom over the bi-stable reed switch and that the switch opens.

As a result the level transmitter will give the correct output signal. See Figure 2.

**Signal output with correctly adjusted transmitter**

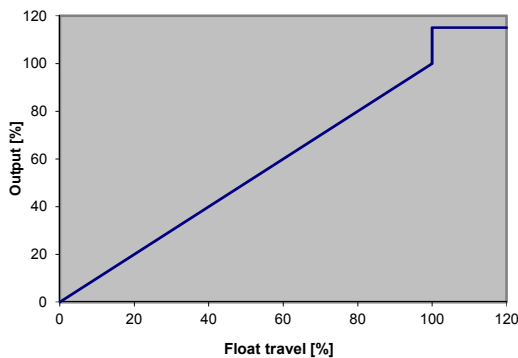

Figure 2

**Faultive signal output with closed bi-stable reed-switch**

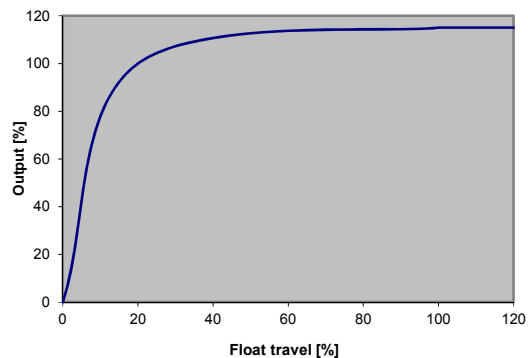
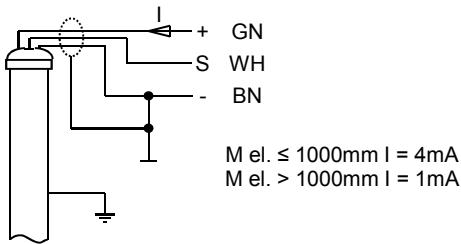

Figure 3

**External electrical connections**



**Description:**

**Transmitter for use with WEKA Visual Level Indicators media temperature ≤ 150°C**

The transmitter is mounted outside of the float chamber opposite to the indication rail (see datasheet 20010501). The magnet inside the float activates the reed switches in the transmitter, depending on the level of liquid in the float chamber, thereby changing the effective value of a resistance network. This converts a current input into a variable voltage output signal that can be fed directly to a remote display or recording instrument. If the liquid level rises above the measuring range of the transmitter (30mm) the output signal jumps to 115% and remains on that limit.

**Product code:**

**29710-010-10      10mm resolution**  
**29710-010-05      5mm resolution**  
**M el. = Measuring length in mm**

[For details see page 2](#)

**Dimensions**

**Internal circuit**

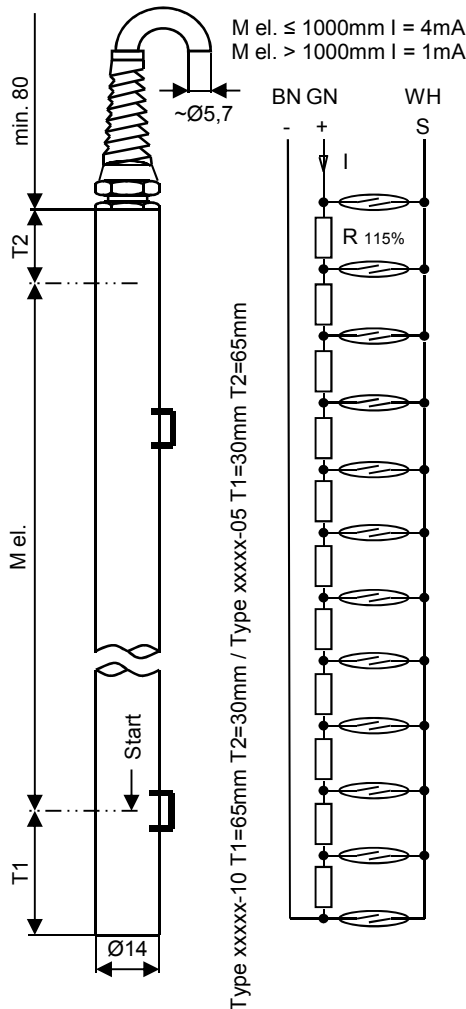

**Resolution**

**29710-010-10      10mm**  
**29710-010-05      5mm**

**Transmitter housing tube dia.**

**Ø 14 / 10      Ø 17 / 14**

**Measuring length "M el."**

200mm (min.) to 4000mm (max.)

Longer M el. available with types 34067, 34167, and 34267 (more piece design)

**Supply current**

M el. ≤ 1000mm I = 4mA  
M el. > 1000mm I = 1mA

**Signal output**

- With R = 10Ω and I = 1mA  
10mV per step (1cm)
- With R = 10Ω and I = 4mA  
40mV per step (1cm)

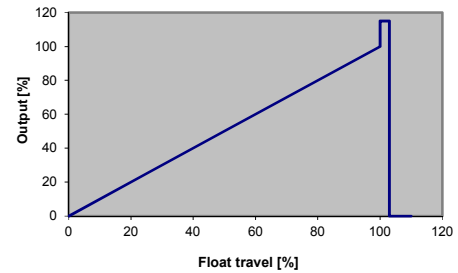

**Operating temperature**

Media temperature -50°C ... +150°C  
Ambient temperature (Ta) -20°C ... +50°C

**Enclosure**

IP68 - 10bar (EN60529)

**Materials**

Housing tube Stainless steel 316 / 316L  
Cable gland PA: with bend protection, grey  
- Seal Perbunan (NBR)  
Cable (Standard 5m) PVC: grey, 3 x 0.34mm<sup>2</sup>, Ø ~ 5.7mm, shielded, largely resistant to oils/petroleum products  
Type label Polyester: silver, black printing

**Fixation**

When ordering level indicators with transmitters, hose clamps are included.  
When ordering transmitters as spare parts, hose clamps are never included and must be ordered separately.  
In case of ordering hose clamps pipe size must be indicated:

For pipe diameter	30...40mm	Part no.	80648
For pipe diameter	40...57mm and 57...80mm	Part no.	84043

**Note**

Please read the instructions in our datasheet 20010501 before performing installation.  
The cable shielding is not connected with the transmitter housing. This connection should be effected by the user.  
The transmitter can be used as a resistor network only when leads WH and BN or WH and GN are connected.

**External electrical connections**

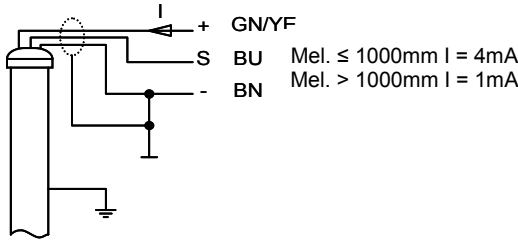

**Description:**

**Transmitter for use with WEKA Visual Level Indicators media temperature ≤ 350°C**

The transmitter is mounted outside of the float chamber opposite to the indication rail (see datasheet 20010501). The magnet inside the float activates the reed switches in the transmitter, depending on the level of liquid in the float chamber, thereby changing the effective value of a resistance network. This converts a current input into a variable voltage output signal that can be fed directly to a remote display or recording instrument. If the liquid level rises above the measuring range of the transmitter (30mm) the output signal jumps to 115% and remains on that limit.

**Product code:**

**29710-W-010-10 10mm resolution**  
**29710-W-010-05 5mm resolution**  
**M el. = Measuring length in mm**

[For details see page 2](#)

**Dimensions**

**Internal circuit**

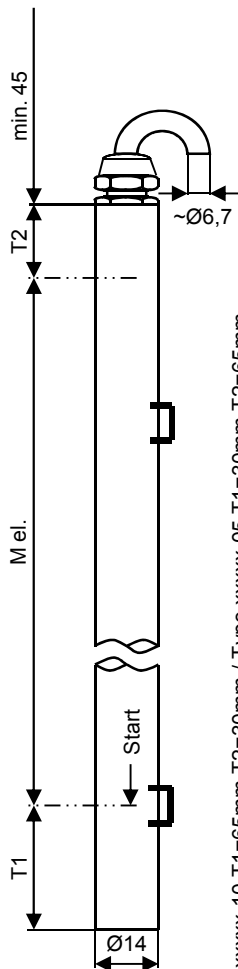

Mel. ≤ 1000mm I = 4mA  
Mel. > 1000mm I = 1mA

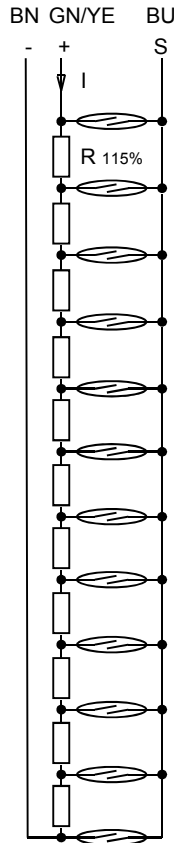

Type xxxxx-10 T1=65mm T2=30mm / Type xxxxx-05 T1=30mm T2=65mm

**Resolution**

**29710-W-010-10 10mm**      **29710-W-010-05 5mm**

**Transmitter housing tube dia.**

Ø 14 / 10      Ø 17 / 14

**Measuring length "M el."**

200mm (min.) to 4000mm (max.)

Longer M el. available with types 34067, 34167, and 34267 (more piece design)

**Supply current**

M el. ≤ 1000mm I = 4mA  
M el. > 1000mm I = 1mA

**Signal output**

- With R = 10Ω and I = 1mA  
10mV per step (1cm)
- With R = 10Ω and I = 4mA  
40mV per step (1cm)

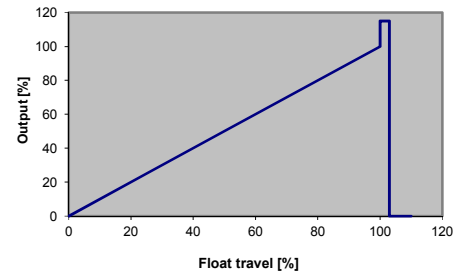

**Operating temperature**

Media temperature -50°C ... +350°C  
Ambient temperature (Ta) -20°C ... +50°C

**Enclosure**

IP68 - 10bar (EN60529)

**Materials**

Housing tube  
Cable gland  
- Seal  
Cable (Standard 5m)

Stainless steel 316 / 316L  
Brass: nickel plated  
FKM / Fluoroelastomere  
Silicone: red, 3 x 0.75mm<sup>2</sup>, Ø ~ 6.7mm, halogen-free, largely resistant to oils/petroleum products  
Polyester: silver, black printing



**Type label**

**Fixation**

When ordering level indicators with transmitters, hose clamps are included.  
When ordering transmitters as spare parts, hose clamps are never included and must be ordered separately.  
In case of ordering hose clamps pipe size must be indicated:

For pipe diameter	30...40mm	Part no.	80648
For pipe diameter	40...57mm and 57...80mm	Part no.	84043

**Note**

Please read the instructions in our datasheet 20010501 before performing installation.  
The transmitter can be used as a resistor network only when leads BU and BN or BU and GN/YE are connected.

**External electrical connections**

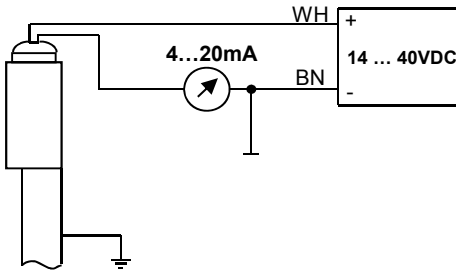

**Description**

**Transmitter, 4...20mA current output for use with WEKA Visual Level Indicators media temperature ≤ 150°C**

The transmitter is mounted outside of the float chamber opposite to the indication rail (see datasheet 20010501). The magnet inside the float activates the reed switches in the transmitter, depending on the level of liquid in the float chamber, thereby changing the effective value of a resistance network. The resulting voltage output is converted by an internal electronic circuit to a 4...20mA signal. If the liquid level rises above the measuring range of the transmitter (30 mm) the output signal jumps to 115% (ca. 22,5mA) and remains on that limit.

**Product code:**

**31967-010-10      10mm resolution**  
**31967-010-05      5mm resolution**  
**M el. = Measuring length in mm**

[For details see page 2](#)

**Dimensions**

**Internal circuit**

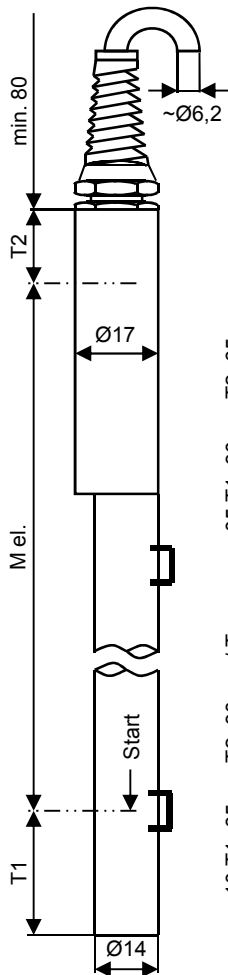

Type xxxxx-10 T1=65mm T2=30mm / Type xxxxx-05 T1=30mm T2=65mm

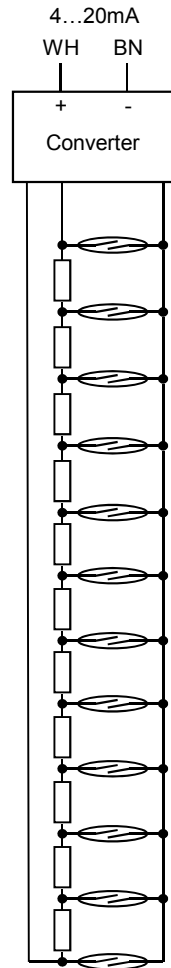

**Resolution**

**31967-010-10      10mm**  
**31967-010-05      5mm**

**Transmitter housing tube dia.**

Ø 14 / 10      Ø 17 / 14

**Measuring length "M el."**

200mm (min.) to 4000mm (max.)

Longer M el. available with types 34067, 34167, and 34267 (more piece design)

**Signal output**

4...20mA current loop

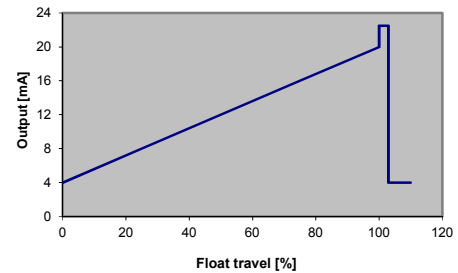

**Loop supply voltage**

14 ... 40VDC

**Operating temperature**

Media temperature      -50°C ... +150°C  
 Ambient temperature (Ta)      -20°C ... +50°C

**Enclosure**

IP68 - 10bar (EN60529)

**Materials**

Housing tube  
 Cable gland  
 - Seal  
 Cable (Standard 5m)

Stainless steel 316 / 316L  
 PA: with bend protection, grey  
 Perbunan (NBR)  
 PVC: grey, 2 x 0.75mm<sup>2</sup>, Ø ~ 6.2mm, shielded, largely resistant to oils/petroleum products  
 Polyester: silver, black printing

**Type label**

**Output load**

max. 100Ω at 14VDC  
 max. 1.4KΩ at 40VDC

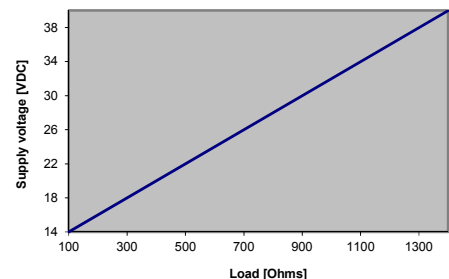

**Fixation**

When ordering level indicators with transmitters, hose clamps are included.

When ordering transmitters as spare parts, hose clamps are never included and must be ordered separately.

In case of ordering hose clamps pipe size must be indicated:

For pipe diameter	30...40mm	Part no.	80648
For pipe diameter	40...57mm and 57...80mm	Part no.	84043

**Note**

Please read the instructions in our datasheet 20010501 before performing installation.



**External electrical connections**

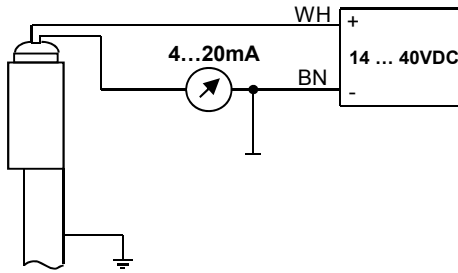

**Description:**

**Transmitter, 4...20mA current output for use with WEKA Visual Level Indicators media temperature ≤ 250°C**

The transmitter is mounted outside of the float chamber opposite to the indication rail (see datasheet 20010501). The magnet inside the float activates the reed switches in the transmitter, depending on the level of liquid in the float chamber, thereby changing the effective value of a resistance network. The resulting voltage output is converted by an internal electronic circuit to a 4...20mA signal. If the liquid level rises above the measuring range of the transmitter (30 mm) the output signal jumps to 115% (ca. 22,5mA) and remains on that limit.

**Product code:**

**31967-W-010-10**    **10mm resolution**  
**31967-W-010-05**    **5mm resolution**  
**M el. = Measuring length in mm**

[For details see page 2](#)

**Dimensions**

**Internal circuit**

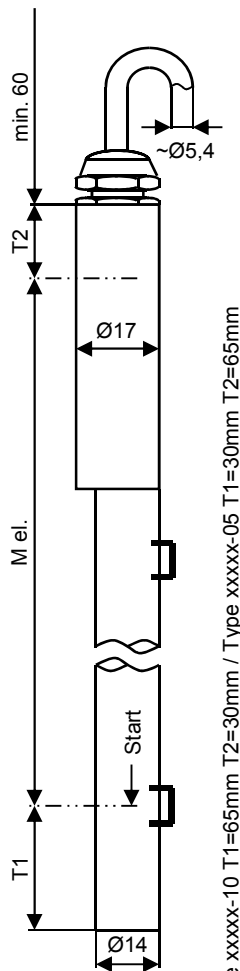

Type xxxxx-10 T1=65mm T2=30mm / Type xxxxx-05 T1=30mm T2=65mm

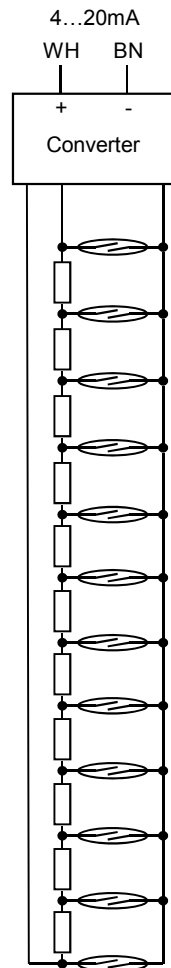

**Resolution**

**31967-W-010-10**    **31967-W-010-05**  
10mm                    5mm

**Transmitter housing tube dia.**

Ø 14 / 10                    Ø 17 / 14

**Measuring length "M el."**

200mm (min.) to 4000mm (max.)

Longer M el. available with types 34067, 34167, and 34267 (more piece design)

**Signal output**

4...20mA current loop

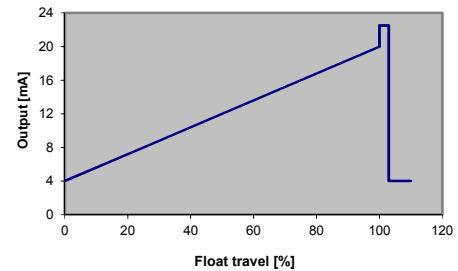

**Loop supply voltage**

14 ... 40VDC

**Operating temperature**

Media temperature                    -50°C ... +250°C  
Ambient temperature (Ta)           -20°C ... +50°C

**Enclosure**

IP68 - 10bar (EN60529)

**Materials**

Housing tube  
Cable gland  
- Seal  
Cable (Standard 5m)

Stainless steel 316 / 316L

Brass: nickel plated

FKM / Fluoroelastomere

Silicone: red; 2 x 0.5mm<sup>2</sup>, Ø ~ 5.4mm, halogen-free,

largely resistant to oils/petroleum products

Polyester: silver, black printing

**Type label**

**Output load**

max. 100Ω at 14VDC  
max. 1.4KΩ at 40VDC

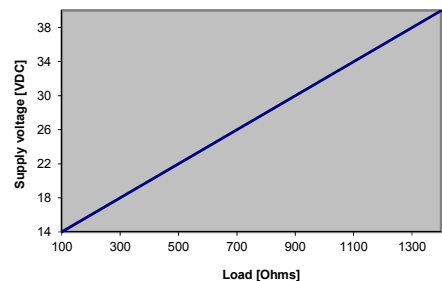

**Fixation**

When ordering level indicators with transmitters, hose clamps are included.

When ordering transmitters as spare parts, hose clamps are never included and must be ordered separately.

In case of ordering hose clamps pipe size must be indicated:

For pipe diameter                    30...40mm                    Part no.                    80648

For pipe diameter                    40...57mm and 57...80mm                    Part no.                    84043

**Note**

Please read the instructions in our datasheet 20010501 before performing installation.

**External electrical connections**

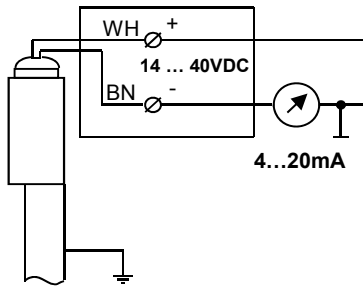

**Description:**

**Transmitter, 4...20mA current output and terminal box connections for use with WEKA Visual Level Indicators media temperature ≤ 150°C**

The transmitter is mounted outside of the float chamber opposite to the indication rail (see datasheet 20010501). The magnet inside the float activates the reed switches in the transmitter, depending on the level of liquid in the float chamber, thereby changing the effective value of a resistance network. The resulting voltage output is converted by an internal electronic circuit to a 4...20mA signal. If the liquid level rises above the measuring range of the transmitter (30 mm) the output signal jumps to 115% (ca. 22,5mA) and remains on that limit.

**Product code:**

**31967-K-010-10 10mm resolution**  
**31967-K-010-05 5mm resolution**  
**M el. = Measuring length in mm**

[For details see page 2](#)

**Dimensions**

**Internal circuit**

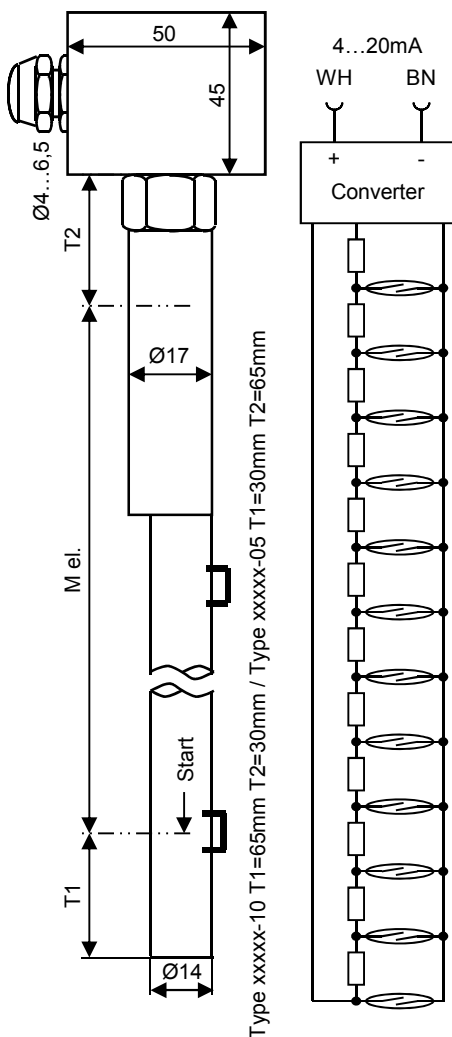

**Resolution**

**31967-K-010-10 10mm**  
**31967-K-010-05 5mm**

**Transmitter housing tube dia.**

**Ø 14 / 10                      Ø 17 / 14**

**Measuring length "M el."**

200mm (min.) to 4000mm (max.)

Longer M el. available with types 34067, 34167, and 34267 (more piece design)

**Signal output**

4...20mA current loop

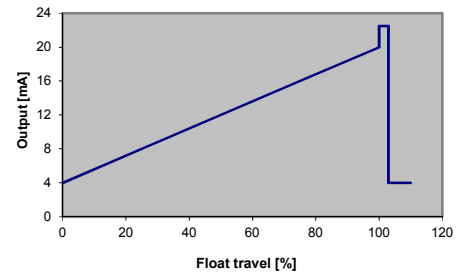

**Loop supply voltage**

14 ... 40VDC

**Operating temperature**

Media temperature -50°C ... +150°C  
 Ambient temperature (Ta) -20°C ... +50°C

**Enclosure**

IP65 (EN60529)

**Materials**

Housing tube  
 Terminal box  
 Cable gland  
 - Cable compatibility  
 - Seal  
 Type label

Stainless steel 316 / 316L  
 Alu. DIN1725: unpainted, 45 x 50 x 30mm  
 Brass: nickel plated, M12 x 1.5  
 Ø 4...6.5mm, max. 2 x 0.5mm2  
 Perbunan (NBR)  
 Polyester: silver, black printing

**Output load**

max. 100Ω at 14VDC  
 max. 1.4KΩ at 40VDC

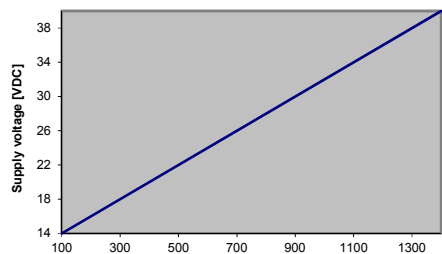

**Fixation**

When ordering level indicators with transmitters, hose clamps are included.

When ordering transmitters as spare parts, hose clamps are never included and must be ordered separately. Load [Ohms]

In case of ordering hose clamps pipe size must be indicated:

For pipe diameter 30...40mm Part no. 80648  
 For pipe diameter 40...57mm and 57...80mm Part no. 84043

**Note**

Please read the instructions in our datasheet 20010501 before performing installation.

Terminal box included.

**External electrical connections**

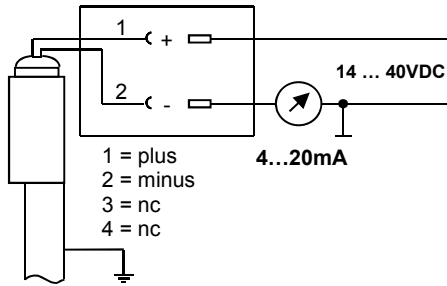

**Description:**

**Transmitter, 4...20mA current output and plug-in connector for use with WEKA Visual Level Indicators media temperature ≤ 150°C**

The transmitter is mounted outside of the float chamber opposite to the indication rail (see datasheet 20010501). The magnet inside the float activates the reed switches in the transmitter, depending on the level of liquid in the float chamber, thereby changing the effective value of a resistance network. The resulting voltage output is converted by an internal electronic circuit to a 4...20mA signal. If the liquid level rises above the measuring range of the transmitter (30 mm) the output signal jumps to 115% (ca. 22,5mA) and remains on that limit.

**Product code:**

[For details see page 2](#)

**31967-KST-010-10 10mm resolution**  
**31967-KST-010-05 5mm resolution**  
**M el. = Measuring length in mm**

**Dimensions**

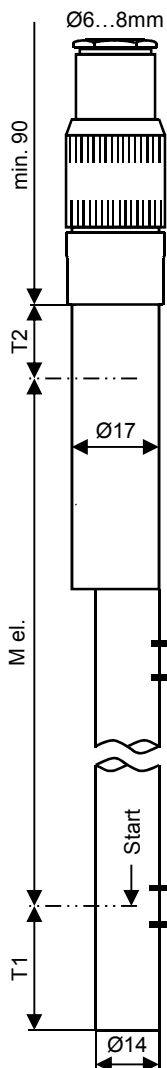

**Internal circuit**

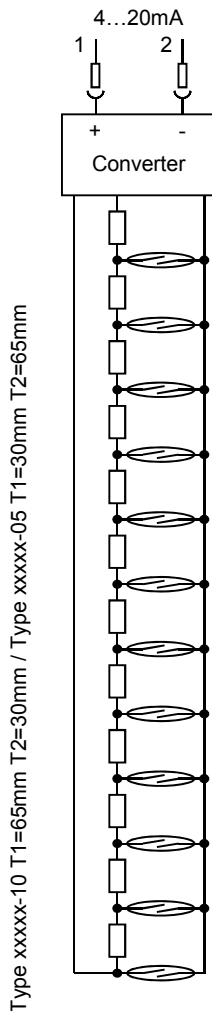

Type xxxxx-10 T1=65mm T2=30mm / Type xxxxx-05 T1=30mm T2=65mm

**Resolution**

**31967-KST-010-10 10mm**      **31967-KST-010-05 5mm**

**Transmitter housing tube dia.**

Ø 14 / 10      Ø 17 / 14

**Measuring length "M el."**

200mm (min.) to 4000mm (max.)  
Longer M el. available with types 34067, 34167, and 34267 (more piece design)

**Signal output**

4...20mA current loop

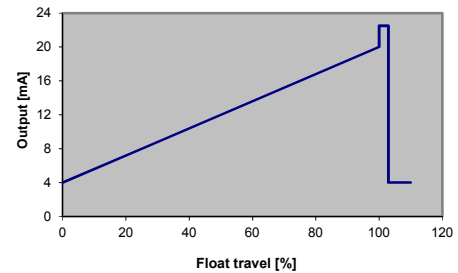

**Loop supply voltage**

14 ... 40VDC

**Operating temperature**

Media temperature -50°C ... +150°C  
Ambient temperature (Ta) -20°C ... +50°C

**Enclosure**

IP67 (EN60529) in plugged configuration

**Materials**

Housing tube  
Connector body  
- Contacts  
- Cable compatibility  
- Seal  
Type label

Stainless steel 316 / 316L  
CuZn alloy: matt chrome-plated  
4-pin, soldered, CuZn alloy, gold-plated  
Ø 6...8mm, Conductors = 1mm<sup>2</sup> max.  
Perbunan (NBR)  
Polyester: silver, black printing

**Output load**

max. 100Ω at 14VDC  
max. 1.4KΩ at 40VDC

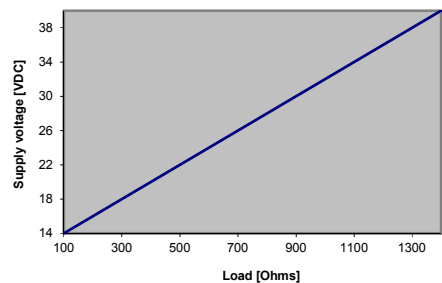

**Fixation**

When ordering level indicators with transmitters, hose clamps are included.  
When ordering transmitters as spare parts, hose clamps are never included and must be ordered separately.  
In case of ordering hose clamps pipe size must be indicated:

For pipe diameter	30...40mm	Part no.	80648
For pipe diameter	40...57mm and 57...80mm	Part no.	84043

**Note**

Please read the instructions in our datasheet 20010501 before performing installation.  
Connector plug included.

**Function:** Intrinsically safe transmitter with ATEX/IECEx certificate for use with WEKA VLI for media temperature  $\leq 150^{\circ}\text{C}$

The transmitter is mounted outside of the float chamber opposite to the indication rail (see datasheet 20010501).

The magnet inside the float activates the reed switches in the transmitter, depending on the level of liquid in the float chamber, thereby changing the effective value of a resistance network. This converts a current input into a variable voltage output signal that can be fed directly to a remote display or recording instrument.

If the liquid level rises above the measuring range of the transmitter the output signal jumps to 115% and remains on that limit.

This transmitter is compatible with Zones 1, 2, 21 and 22 for gas groups IIA, IIB, IIC, IIIA, IIIB and IIIC.

The transmitter must be connected with a certified energy limiting device (e.g. Zener barrier) installed in a safe area. This device guarantees the electrical limit values specified below, including the cable. The metal housing of the transmitter must be connected to protection ground.

**Certificate**



II 2 G Ex ia IIC T4 Gb

II 2 D Ex ia IIIC T115°C Db

SEV 17 ATEX 0104

IECEx SEV 17.0001

**Dimensions**

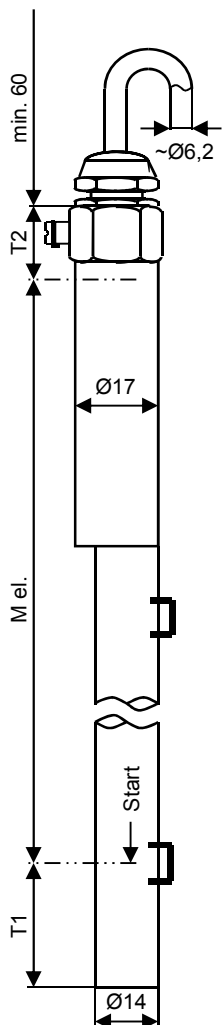

**Internal circuit**

Type xxxxx-10 T1=65mm T2=30mm / Type xxxxx-05 T1=30mm T2=65mm

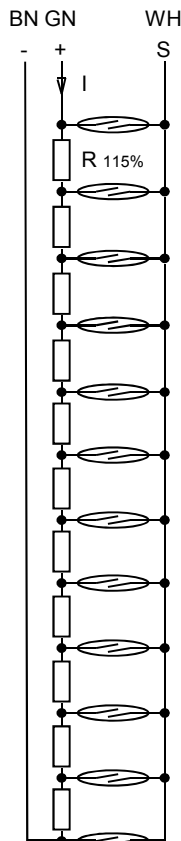

**External electrical connections**

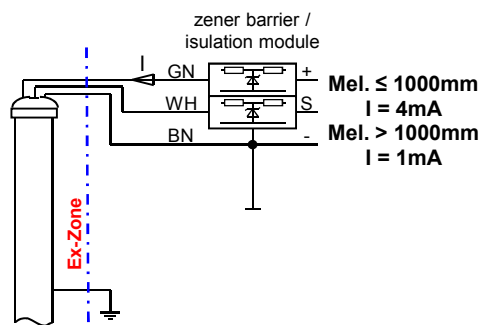

**Product code:**  
[For details see page 2](#)

**29710-NI-10**      **10mm resolution**  
**29710-NI-05**      **5mm resolution**  
**M el. = Measuring length in mm**

**Resolution**  
**Transmitter tube dia.**  
**Measuring length "M el."**

**29710-NI-10**      **29710-NI-05**  
10mm                      5mm  
Ø 14 / 10                      Ø 17 / 14  
200mm (min.) ... 4000mm (max.)

**Supply current**  
M el.  $\leq 1000\text{mm}$     I = 4mA  
M el.  $> 1000\text{mm}$     I = 1mA

**Operating temperatures**

Media temperature	Ambient temperature	Temperature class
-50°C...+150°C	-50°C...+50°C	T4 (115°C)

For dust explosion hazardous areas (D) the media temperature has to be considered instead of the surface temperature.

**Enclosure**

IP68 - 10bar (EN60529)

**Signal output**

- with R = 10Ω and I = 1mA  
10mV per step (1cm) For 29710-NI-10 one step = 1cm and for 29710-NI-05 one step = 5mm
- with R = 10Ω and I = 4mA  
40mV per step (1cm) For 29710-NI-10 one step = 1cm and for 29710-NI-05 one step = 5mm

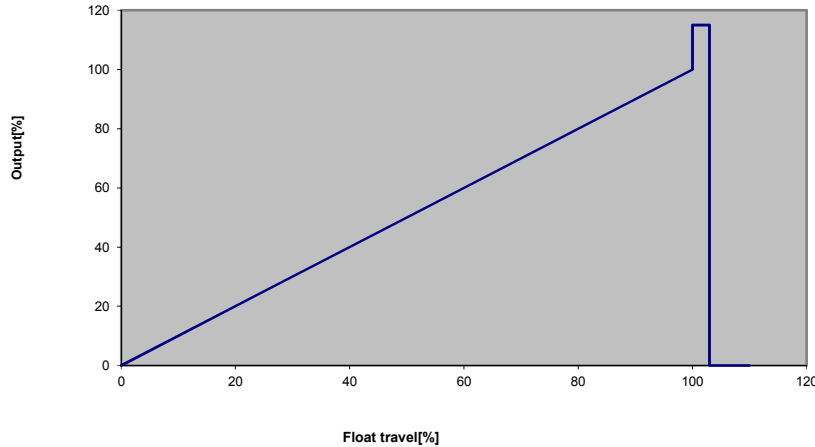

**Materials**

Housing tube	Stainless steel 316 / 316L	
Cable gland	Brass, nickel-plated	
- Seal	PA / NBR	
Cable (Standard 5m)	Silicone, red, 3 x 0,5mm <sup>2</sup> , Ø ~6,2mm, largely resistant to oils/petroleum products, halogen-free	
Type label	Stainless steel, lasered	

**Electrical limit values**

U<sub>max</sub> = 15VDC  
I<sub>max</sub> = 4mA

**Safety related limit values**

U<sub>i</sub> = max. 22,6V  
I<sub>i</sub> = max. 160mA  
P<sub>i</sub> = max. 900mW  
C<sub>i</sub> ≈ 0  
L<sub>i</sub> ≈ 0

**Fixation**

When ordering level indicators with transmitters, hose clamps are included.  
When ordering transmitters as spare parts, hose clamps are never included and must be ordered separately.  
In case of ordering hose clamps pipe size must be indicated.

For pipe diameter	30...40mm	P/O	80648
For pipe diameter	40...57mm and 57...80mm	P/O	84043

**Note**

Please read the instructions in our datasheet 20010501 before performing installation.  
This device is maintenancefree and repair work is prohibited.  
The cable must be durably installed.  
The relevant certificates are available at [www.weka-ag.ch](http://www.weka-ag.ch) These information has to be considered additionally.

**Function:** Intrinsically safe transmitter with ATEX/IECEx certificate for use with WEKA VLI for media temperature  $\leq 150^{\circ}\text{C}$

The transmitter is mounted outside of the float chamber opposite to the indication rail (see datasheet 20010501).

The magnet inside the float activates the reed switches in the transmitter, depending on the level of liquid in the float chamber, thereby changing the effective value of a resistance network. The resulting voltage output is converted by an internal electronic circuit to a 4...20mA signal.

If the liquid level rises above the measuring range of the transmitter the output signal jumps to 115% and remains on that limit.

This transmitter is compatible with Zones 1, 2, 21 and 22 for gas groups IIA, IIB, IIC, IIIA, IIIB and IIIC.

The transmitter must be connected with a certified energy limiting device (e.g. Zener barrier) installed in a safe area. This device guarantees the electrical limit values specified below, including the cable. The metal housing of the transmitter must be connected to protection ground.

**Certificate**



II 2 G Ex ia IIC T4 Gb

II 2 D Ex ia IIIC T115°C Db

SEV 17 ATEX 0104

IECEx SEV 17.0001

**Dimensions**

**Internal circuit**

**External electrical connections**

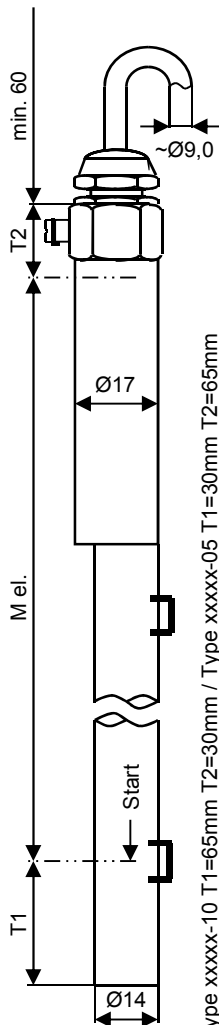

Type xxxxx-10 T1=65mm T2=30mm / Type xxxxx-05 T1=30mm T2=65mm

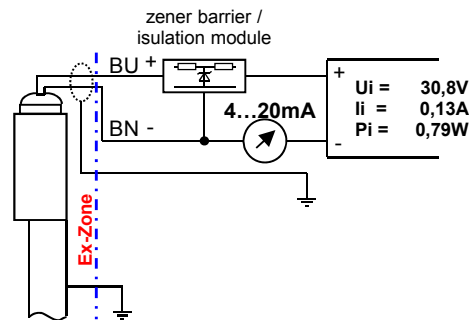
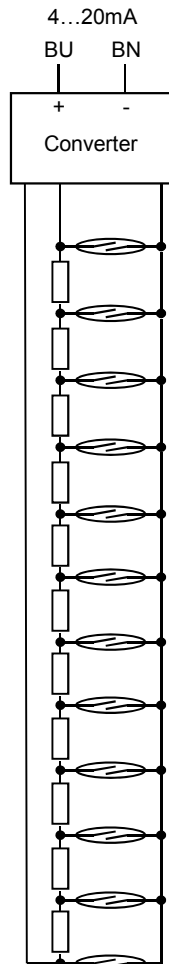

**Product code:**  
[For details see page 2](#)

**32607-NI-10**      **10mm resolution**  
**32607-NI-05**      **5mm resolution**  
**M el. = Measuring length in mm**

<b>Resolution</b>	<b>32607-NI-10</b>	<b>32607-NI-05</b>
	10mm	5mm
<b>Transmitter tube dia.</b>	Ø 14 / 10	Ø 17 / 14
<b>Measuring length "M el."</b>	200mm (min.) ... 4000mm (max.)	

**Supply voltage**  
14VDC ... 30VDC

**Operating temperatures**

Media temperature	Ambient temperature	Temperature class
-50°C...+150°C	-50°C...+50°C	T4 (115°C)

For dust explosion hazardous areas (D) the media temperature has to be considered instead of the surface temperature.

**Enclosure**

IP68 - 10bar (EN60529)

**Signal output**

4...20mA current loop

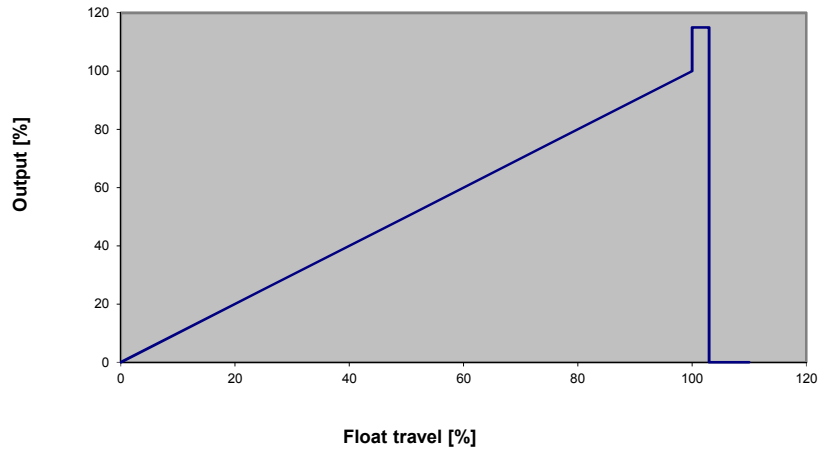

**Output load (including energy limiting device and cables)**

max. 100Ohm at 14VDC  
max. 900Ohm at 30VDC

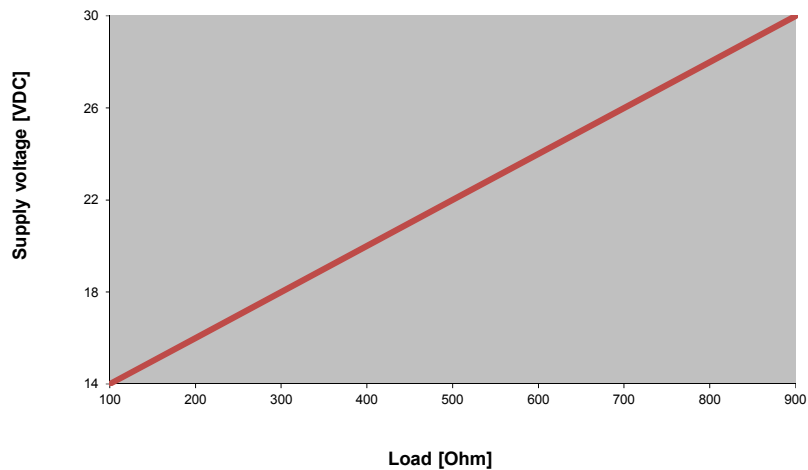

**Materials**

Housing tube  
Cable gland  
- Seal  
Cable  
shielded (standard)

Stainless steel 316 / 316L  
Brass, nickel-plated  
PA / NBR



5m, Silicone, black 2 x 1,0mm<sup>2</sup>, Ø ~9,0mm, largely resistant to oils/petroleum products, halogen-free

Type label

Stainless steel, lasered

**Electrical limit values**

U<sub>max</sub> = 31VDC  
I<sub>max</sub> = 25mA

**Safety related limit values**

U<sub>i</sub> = max. 30,8V  
I<sub>i</sub> = max. 130mA  
P<sub>i</sub> = max. 790mW  
C<sub>i</sub> ≈ max. 49nF  
L<sub>i</sub> ≈ 0mH

**Fixation**

When ordering level indicators with transmitters, hose clamps are included.  
When ordering transmitters as spare parts, hose clamps are never included and must be ordered separately.  
In case of ordering hose clamps pipe size must be indicated.

For pipe diameter	30...40mm	P/O	80648
For pipe diameter	40...57mm and 57...80mm	P/O	84043

**Note**

Please read the instructions in our datasheet 20010501 before performing installation.  
This device is maintenancefree and repair work is prohibited.  
The cable must be durably installed.  
The relevant certificates are available at [www.weka-ag.ch](http://www.weka-ag.ch) These information has to be considered additionally.

**Function:** Transmitter Ex d with ATEX/IECEX certificate for use with WEKA VLI for media temperature ≤ 150°C

The transmitter is mounted outside of the float chamber opposite to the indication rail (see datasheet 20010501).

The magnet inside the float activates the reed switches in the transmitter, depending on the level of liquid in the float chamber, thereby changing the effective value of a resistance network. This converts a current input into a variable voltage output signal that can be fed directly to a remote display or recording instrument.

If the liquid level rises above the measuring range of the transmitter the output signal jumps to 115% and remains on that limit.

This transmitter is compatible with Zones 1, 2, 21 and 22 for gas groups IIA, IIB, IIC, IIIA, IIIB and IIIC.

The metal housing of the transmitter must be connected to protection ground.

**Certificate**



**II 2 G Ex db IIC T6 Gb**  
**II 2 D Ex tb IIIC T85°C Db**

**SEV 17 ATEX 0104**  
**IECEX SEV 17.0001**

Temperature class resp. max. surface temperature refers to below mentioned table.

**Dimensions**

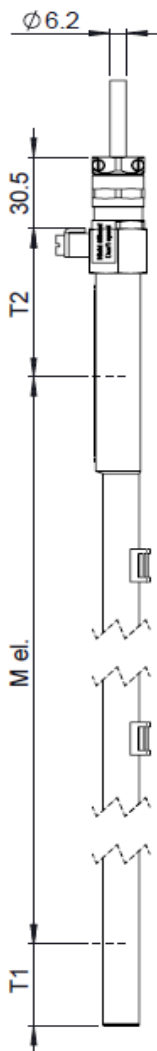

**Internal circuit**

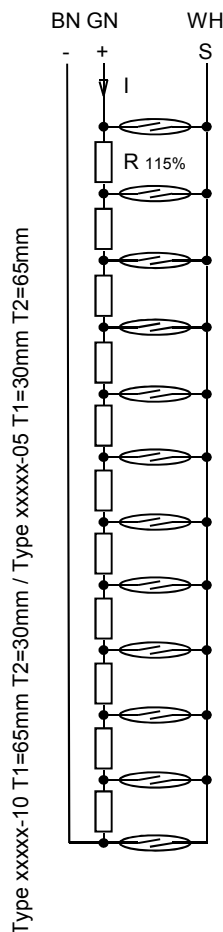

**External electrical connections**

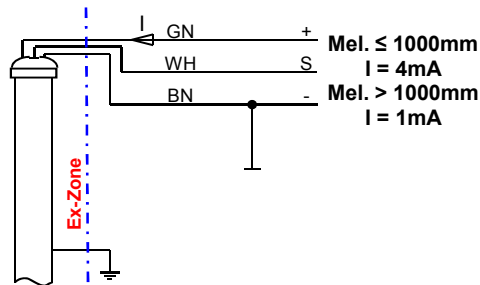

**Product code:**  
[For details see page 2](#)

**29710-ND-10**      **10mm resolution**  
**29710-ND-05**      **5mm resolution**  
**M el. = Measuring length in mm**

<b>Resolution</b>	<b>29710-ND-10</b>	<b>29710-ND-05</b>
	10mm	5mm
<b>Transmitter tube dia.</b>	Ø 14 / 10	Ø 17 / 14
<b>Measuring length "M el."</b>	200mm (min.) ... 4000mm (max.)	

**Supply current**  
M el. ≤ 1000mm    I = 4mA  
M el. > 1000mm    I = 1mA

**Operating temperatures**

Media temperature	Ambient temperature	Temperature class
-50°C...+150°C	-50°C...+50°C	T4 / T105°C
-50°C...+135°C	-50°C...+50°C	T4 / T100°C
-50°C...+100°C	-50°C...+50°C	T5 / T95°C
-50°C...+85°C	-50°C...+50°C	T6 / T85°C

**Enclosure**

IP66 & IP68 - 10bar (EN60529)



**Signal output**

- with R = 10Ω and I = 1mA  
10mV per step (1cm)                      For 29710-ND-10 one step = 1cm and for 29710-ND-05 one step = 5mm
- with R = 10Ω and I = 4mA  
40mV per step (1cm)                      For 29710-ND-10 one step = 1cm and for 29710-ND-05 one step = 5mm

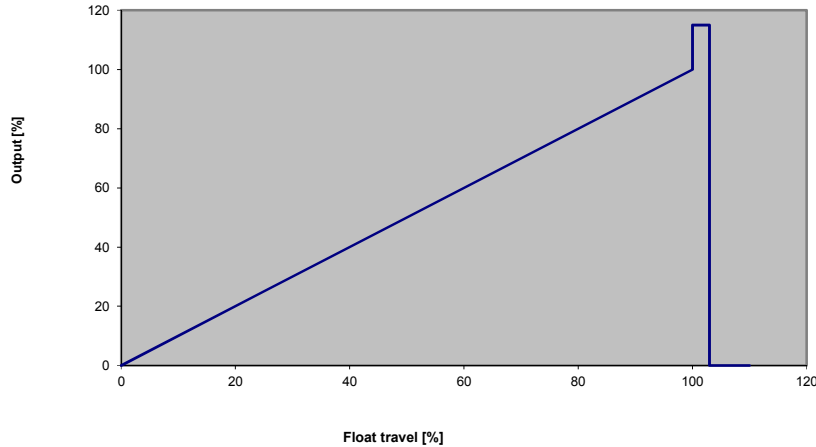

**Materials**

Housing tube	Stainless steel 316 / 316L	
Cable gland	Brass, nickel-plated	
- Seal	PA / FPM	
Cable (Standard 5m)	Silicone, red, 3 x 0,5mm <sup>2</sup> , Ø ~6,2mm, largely resistant to oils/petroleum products, halogen-free	
Type label	Stainless steel, lasered	

**Electrical limit values**

U<sub>max</sub> = 15VDC  
I<sub>max</sub> = 4mA

**Fixation**

When ordering level indicators with transmitters, hose clamps are included.  
When ordering transmitters as spare parts, hose clamps are never included and must be ordered separately.  
In case of ordering hose clamps pipe size must be indicated.

For pipe diameter	30...40mm	P/O	80648
For pipe diameter	40...57mm and 57...80mm	P/O	84043

**Note**

Please read the instructions in our datasheet 20010501 before performing installation.  
This device is maintenancefree and repair work is prohibited.  
The cable must be durably installed.  
The relevant certificates are available at [www.weka-ag.ch](http://www.weka-ag.ch) These information has to be considered additionally.

Function: Transmitter Ex d with ATEX/IECEX certificate for use with WEKA VLI for media temperature  $\leq 150^{\circ}\text{C}$

The transmitter is mounted outside of the float chamber opposite to the indication rail (see datasheet 20010501).

The magnet inside the float activates the reed switches in the transmitter, depending on the level of liquid in the float chamber, thereby changing the effective value of a resistance network. The resulting voltage output is converted by an internal electronic circuit to a 4...20mA signal.

If the liquid level rises above the measuring range of the transmitter the output signal jumps to 115% and remains on that limit.

This transmitter is compatible with Zones 1, 2, 21 and 22 for gas groups IIA, IIB, IIC, IIIA, IIIB and IIIC.

The metal housing of the transmitter must be connected to protection ground.

Certificate



II 2 G Ex db IIC T6 Gb  
II 2 D Ex tb IIIC T85°C Db

SEV 17 ATEX 0104  
IECEX SEV 17.0001

Temperature class resp. max. surface temperature refers to below mentioned table.

Dimensions

Internal circuit

External electrical connections

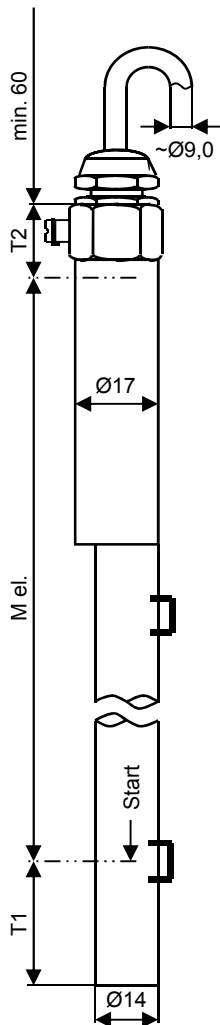

Type xxxxx-10 T1=65mm T2=30mm / Type xxxxx-05 T1=30mm T2=65mm

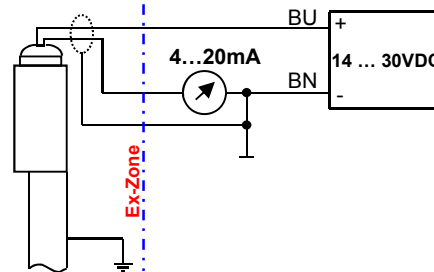
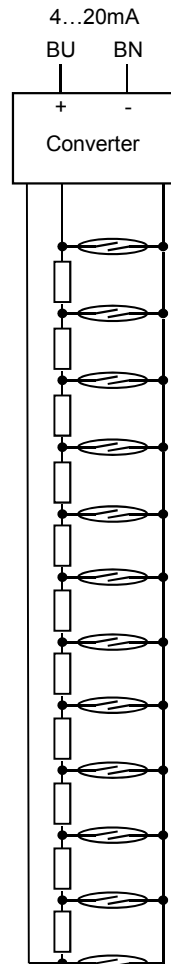

Product code:  
[For details see page 2](#)

32608-ND-10 10mm resolution  
32608-ND-05 5mm resolution  
M el. = Measuring length in mm

Resolution  
Transmitter tube dia.  
Measuring length "M el."

32608-ND-10 32608-ND-05  
10mm 5mm  
Ø 14 / 10 Ø 17 / 14  
200mm (min.) ... 4000mm (max.)

Supply voltage  
14VDC ... 30VDC

Operating temperatures

Media temperature	Ambient temperature	Temperature class
-50°C...+150°C	-50°C...+50°C	T4 / T105°C
-50°C...+135°C	-50°C...+50°C	T4 / T100°C
-50°C...+100°C	-50°C...+50°C	T5 / T95°C
-50°C...+85°C	-50°C...+50°C	T6 / T85°C

Enclosure

IP66 & IP68 - 10bar (EN60529)

**Signal output**

4...20mA current loop

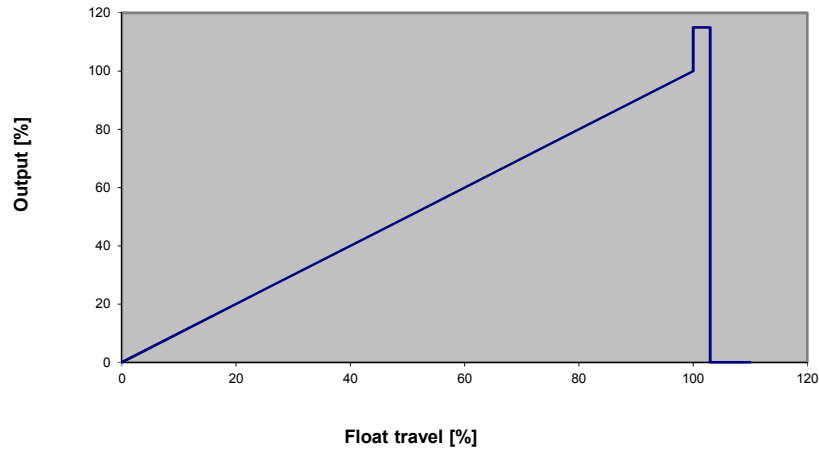

**Output load (including energy limiting device and cables)**

max. 100Ohm at 14VDC  
max. 900Ohm at 30VDC

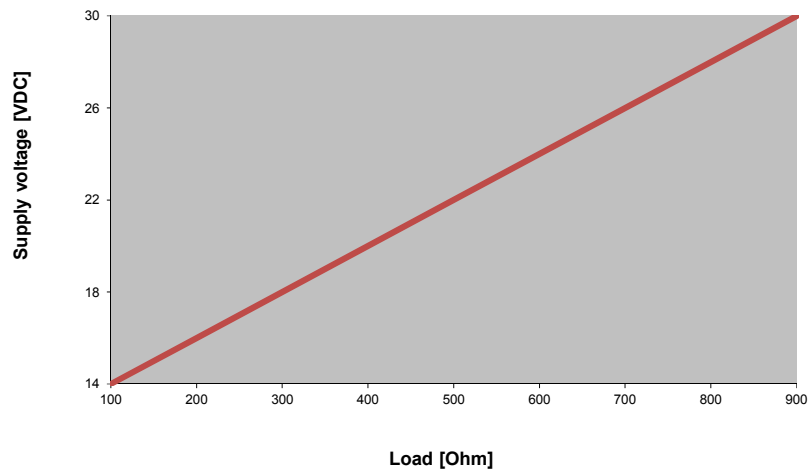

**Materials**

Housing tube	Stainless steel 316 / 316L
Cable gland	Brass, nickel-plated
- Seal	PA / FPM
Cable shielded (standard)	5m, Silicone, black 2 x 1,0mm <sup>2</sup> , Ø ~9,0mm, largely resistant to oils/petroleum products, halogen-free
Type label	Stainless steel, lasered



**Electrical limit values**

U<sub>max</sub> = 31VDC  
I<sub>max</sub> = 25mA

**Fixation**

When ordering level indicators with transmitters, hose clamps are included.  
When ordering transmitters as spare parts, hose clamps are never included and must be ordered separately.  
In case of ordering hose clamps pipe size must be indicated.

For pipe diameter	30...40mm	P/O	80648
For pipe diameter	40...57mm and 57...80mm	P/O	84043

**Note**

Please read the instructions in our datasheet 20010501 before performing installation.  
This device is maintenancefree and repair work is prohibited.  
The cable must be durably installed.  
The relevant certificates are available at [www.weka-ag.ch](http://www.weka-ag.ch) These information has to be considered additionally.

External electrical connections

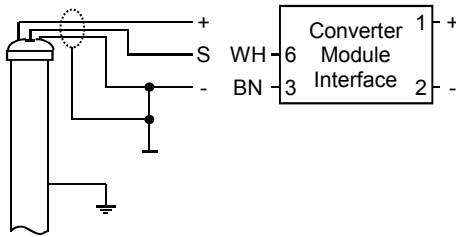

**Description:** Transmitter for use with HART®, PA® or Foundation Fieldbus™ converter module interface, 4...20mA current output and with WEKA Visual Level Indicators media temperature ≤ 150°C

The transmitter is mounted outside of the float chamber opposite to the indication rail (see datasheet 20010501). The magnet inside the float activates the reed switches in the transmitter, depending on the level of liquid in the float chamber, thereby changing the effective value of a resistance network. The resulting voltage output is converted into a 2-wire 4...20mA current output with superimposed HART®, PA® or FF™ digital communication. The measuring length of transmitter (M el.) must be larger than the measuring length of the indicator (M). Refer to the table below. Transmitter settings are selected through the Converter Module Interface.

**Product code:** 29710-R-010-10 10mm Resolution  
 29710-R-010-05 5mm Resolution  
 M el. = (see below)

Dimensions

Internal circuit

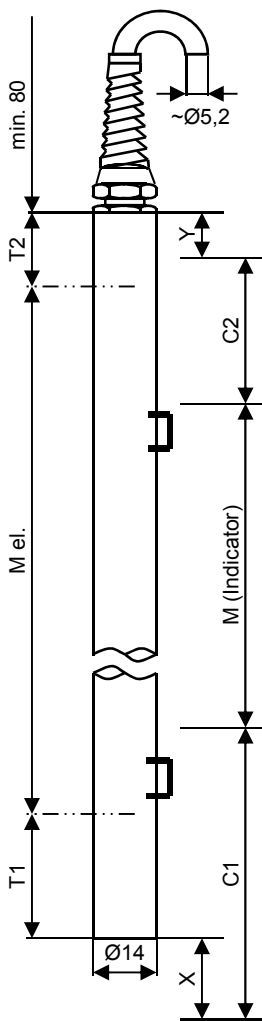

Type xxxxx-10 T1/T2 = Depends on settings of Converter Module Interface  
 Type xxxxx-05 T1/T2 = Depends on settings of Converter Module Interface

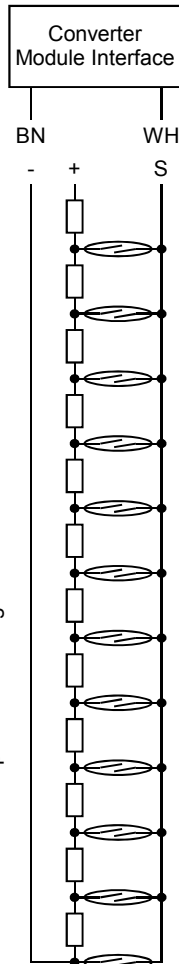

Measuring length "M el." 250mm (min.) to 4000mm (max.)

Level Indicator	Media Density	x	y	Measuring Length (M el.)
Type	[g/cm <sup>3</sup> ]	[mm]	[mm]	[mm]
34000-A /-K u. 34110-K	≥ 0,6	20	10	= M + 330
34000-A /-K u. 34110-K	≥ 0,7	20	10	= M + 230
34000-A /-K u. 34110-K	≥ 0,8	20	10	= M + 160
34000-A /-K u. 34110-K	≥ 1,0	20	10	= M + 120
Standard Line -A /-K High Pressure Line -A /-K Petro Line -A /-K				= M + 180

For others, calculate M el. as follows:

M el. [mm] = M + C1 - X - 65 + C2 + Y - 30 (M = measuring length of indicator)

HART®, PA® or FF™ Converter	<a href="#">HART 37383</a> <a href="#">HART 40038</a>	<a href="#">HART 37384</a> <a href="#">PA + FF 40268</a>
Transmitter housing tube dia.	Ø 14 / 10	Ø 17 / 14
Resolution	10mm	5mm
Power supply	Refer to HART®, PA® or FF™ Converter Module Interface data sheet	
Operating temperature	Media temperature -50°C ... +150°C Ambient temperature (Ta) -20°C ... +50°C	
Enclosure	IP68 - 10bar (EN60529)	
Materials	Housing tube Stainless steel 316 / 316L Cable gland PA: with cable bend protection, grey - Seal Perbunan (NBR) Cable (Standard 5m) PVC: grey, 2 x 0.34mm <sup>2</sup> , Ø ~ 5,2mm, shielded, largely resistant to oils/petroleum products	
Type label	Polyester: silver, black printing	

Fixation

When

For pipe diameter	30...40mm	Part no.	80648
For pipe diameter	40...57mm and 57...80mm	Part no.	84043

Note

Please read the instructions in our datasheet 20010501 before performing installation.

The cable shielding is not connected with the transmitter housing. This connection should be effected by the user.

The transmitter can be connected as resistor network only when leads WH and BN are connected.

The transmitter can be inverted with the cable entry at the bottom. Setting of the converter module interface must then be changed.

External electrical connections

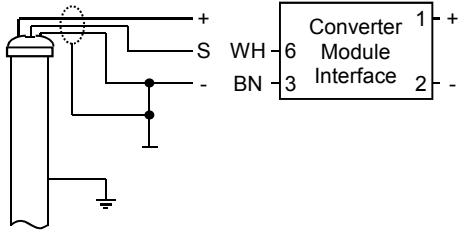

Description:

Intrinsically safe transmitter with HART® converter module interface and 4...20 mA current output for use with WEKA Visual Level Indicators media temperature ≤ 150°C

The transmitter is mounted outside of the float chamber opposite to the indication rail (see datasheet 20010501). The magnet inside the float activates the reed switches in the transmitter, depending on the level of liquid in the float chamber, thereby changing the effective value of a resistance network. The resulting voltage output is converted into a 2-wire 4...20mA current output with superimposed HART® digital communication.

The measuring length of transmitter (M el.) must be larger than the measuring length of the indicator (M). Refer to the table below. Transmitter settings are selected through the Converter Module Interface.

**Product code:** 29710-R-NI-10 10mm Resolution  
29710-R-NI-05 5mm Resolution  
M el. = (see below)

**Measuring length "M el."** 250mm (min.) to 4000mm (max.)

Dimensions

Internal circuit

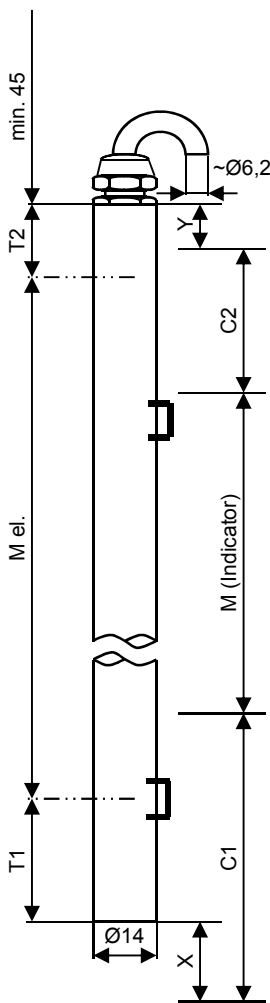

Type xxxxx-10 T1/T2 = Depends on settings of Converter Module Interface  
Type xxxxx-05 T1/T2 = Depends on settings of Converter Module Interface

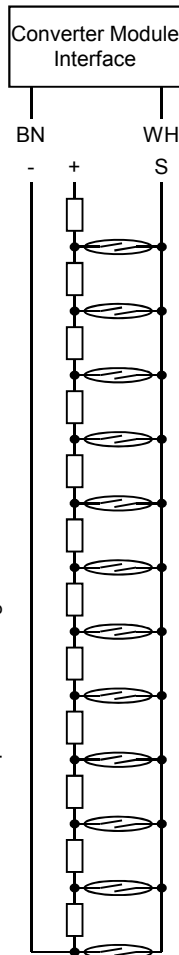

Level Indicator	Media Density	x	y	Measuring Length (M el.)
Type	[g/cm3]	[mm]	[mm]	[mm]
34000-A /-K u. 34110-K	≥ 0,6	20	10	= M + 330
34000-A /-K u. 34110-K	≥ 0,7	20	10	= M + 230
34000-A /-K u. 34110-K	≥ 0,8	20	10	= M + 160
34000-A /-K u. 34110-K	≥ 1,0	20	10	= M + 120
Standard Line -A /-K				= M + 180
High Pressure Line -A /-K				
Petro Line -A /-K				

For others, calculate M el. as follows:

M el. [mm] = M + C1 - X - 65 + C2 + Y - 30 (M = measuring length of indicator)

HART® Converter [HART 37384](#)

Transmitter housing tube dia. refer to type 29710-NI

Resolution refer to type 29710-NI

Power supply Refer to HART® Converter data sheet

Operating temperature refer to type 29710-NI

Enclosure refer to type 29710-NI

Materials refer to type 29710-NI

Certificates refer to type 29710-NI

Fixation refer

Note refer to type 29710-NI

External electrical connections

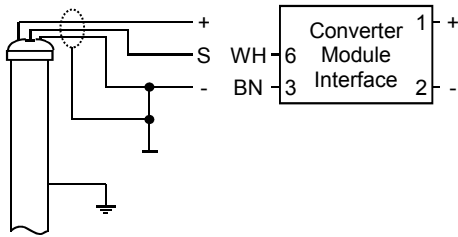

**Description:** Transmitter for use with HART®, PA® or Foundation Fieldbus™ converter module interface, 4...20mA current output and with WEKA Visual Level Indicators media temperature ≤ 350°C

The transmitter is mounted outside of the float chamber opposite to the indication rail (see datasheet 20010501). The magnet inside the float activates the reed switches in the transmitter, depending on the level of liquid in the float chamber, thereby changing the effective value of a resistance network. The resulting voltage output is converted into a 2-wire 4...20mA current output with superimposed HART®, PA® or FF™ digital communication. The measuring length of transmitter (M el.) must be larger than the measuring length of the indicator (M). Refer to the table below. Transmitter settings are selected through the Converter Module Interface.

**Product code:** 29710-R-W-010-10 10mm Resolution  
 For details see page 2 29710-R-W-010-05 5mm Resolution  
 M el. = (see below)

Dimensions

Internal circuit

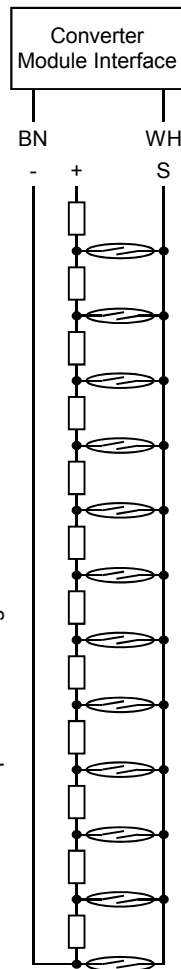
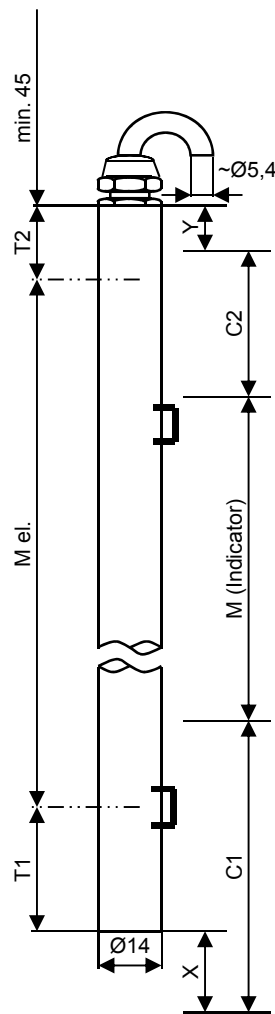

Measuring length "M el." 250mm (min.) to 4000mm (max.)

Level Indicator	Media Density	x	y	Measuring Length (M el.)
Type	[g/cm <sup>3</sup> ]	[mm]	[mm]	[mm]
34000-A /-K u. 34110-K	≥ 0,6	20	10	= M + 330
34000-A /-K u. 34110-K	≥ 0,7	20	10	= M + 230
34000-A /-K u. 34110-K	≥ 0,8	20	10	= M + 160
34000-A /-K u. 34110-K	≥ 1,0	20	10	= M + 120
Standard Line -A /-K High Pressure Line -A /-K Petro Line -A /-K				= M + 180

For others, calculate M el. as follows:

M el. [mm] = M + C1 - X - 65 + C2 + Y - 30 (M = measuring length of indicator)

- HART®, PA® or FF™ Converter** [HART 37383](#) [HART 37384](#)  
[HART 40038](#) [PA + FF 40268](#)
- Transmitter housing tube dia.** Ø 14 / 10      Ø 17 / 14
- Resolution** 10mm      5mm
- Power supply** Refer to HART®, PA® or FF™ Converter Module Interface data sheet
- Operating temperature**  
Media temperature -50°C ... +350°C  
Ambient temperature (Ta) -20°C ... +50°C
- Enclosure** IP68 - 10bar (EN60529)
- Materials**  
Housing tube Stainless steel 316 / 316L  
Cable gland Brass: nickel plated  
- Seal FKM / Fluoroelastomere  
Cable (Standard 5m) Silicone: red, 2 x 0.5mm<sup>2</sup>, Ø ~ 5,4mm, halogen-free, largely resistant to oils/petroleum  
Polyester: silver, black printing
- Type label**

Fixation

When

- For pipe diameter 30...40mm Part no. 80648
- For pipe diameter 40...57mm and 57...80mm Part no. 84043

Note

Please read the instructions in our datasheet 20010501 before performing installation.  
 The cable shielding is not connected with the transmitter housing. This connection should be effected by the user.  
 In case of Ex, the cable must be durably installed. This device is maintenancefree and repair work is prohibited.  
 The transmitter can be inverted with the cable entry at the bottom. Setting of the converter module interface must then be changed.

External electrical connections

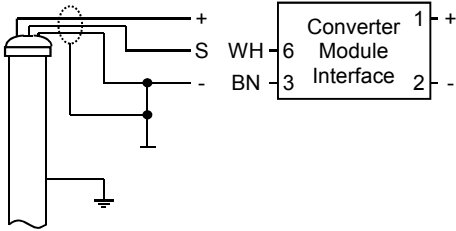

Description:

Flameproof enclosures transmitter for use with HART® converter module interface and 4...20mA current output for use with WEKA Level Indicators media temperature ≤ 150°C

The transmitter is mounted outside of the float chamber opposite to the indication rail (see datasheet 20010501). The magnet inside the float activates the reed switches in the transmitter, depending on the level of liquid in the float chamber, thereby changing the effective value of a resistance network. The resulting voltage output is converted into a 2-wire 4...20mA current output with superimposed HART® digital communication.

The measuring length of transmitter (M el.) must be larger than the measuring length of the indicator (M). Refer to the table below. Transmitter settings are selected through the Converter Module Interface.

Product code: **29710-R-ND-10** 10mm Resolution  
**29710-R-ND-05** 5mm Resolution  
M el. = (see below)

Measuring length "M el." 250mm (min.) to 4000mm (max.)

Dimensions

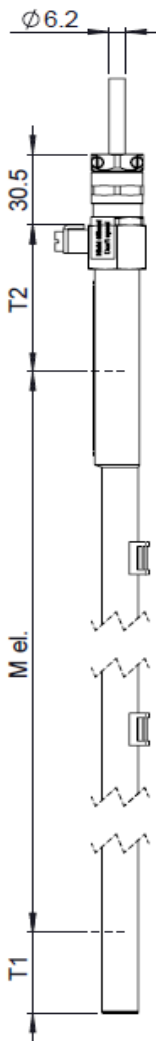

Internal circuit

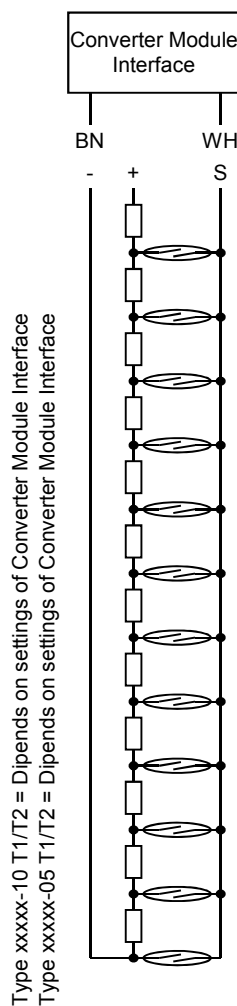

Level Indicator	Media Density	x	y	Measuring Length (M el.)
Type	[g/cm3]	[mm]	[mm]	[mm]
34000-A /-K u. 34110-K	≥ 0,6	20	10	= M + 330
34000-A /-K u. 34110-K	≥ 0,7	20	10	= M + 230
34000-A /-K u. 34110-K	≥ 0,8	20	10	= M + 160
34000-A /-K u. 34110-K	≥ 1,0	20	10	= M + 120
Standard Line -A /-K High Pressure Line -A /-K Petro Line -A /-K				= M + 180

For others, calculate M el. as follows:

M el. [mm] = M + C1 - X - 65 + C2 + Y - 30 (M = measuring length of indicator)

HART® Converter

[HART 38021](#)

Transmitter housing tube dia.

refer to type 29710-ND

Resolution

refer to type 29710-ND

Power supply

Refer to HART® Converter data sheet

Operating temperature

refer to type 29710-ND

Enclosure

refer to type 29710-ND

Materials

refer to type 29710-ND

Certificates

refer to type 29710-ND

Fixation refer

Note refer to type 29710-ND

External electrical connections:

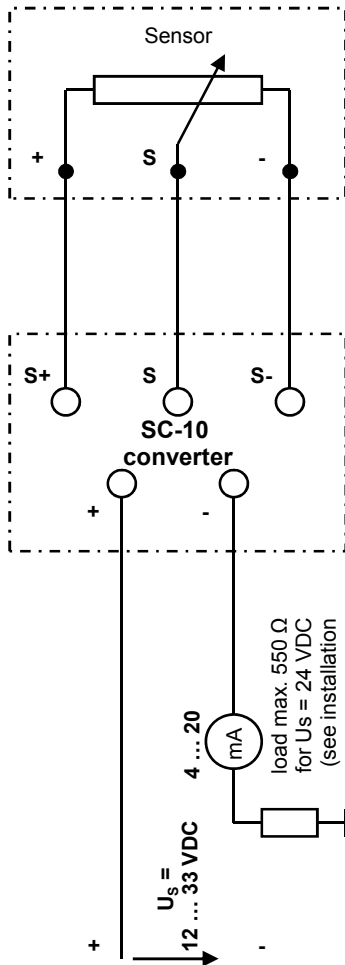

Description: **SC-10**  
Converter with 4 ... 20 mA current output (sink)  
for 3-wire- transmitters (29710-xx).

The output of the transmitter mounted at the float chamber is a resistive signal analog to the filling level of the tank. The converter feeds the transmitter with a constant current and converts the resistive signal into a 4 ... 20 mA output. The operating temperature of the converter is limited. To For higher media temperatures it could be necessary to separate the converter from the VLI (Visual Level Indicator). The max. distance is 10 m.

<b>Product code</b>	45755
<b>Dimensions</b>	80 x 75 x 60 mm
<b>Cable glands</b>	Threads, M20 x 1.5
<b>Installation</b>	52 x 63 mm, 2 screws M4 on fixation holder (860528) at VLI or loose for separate installation

<b>Specifications</b>	
Power supply voltage $U_s$	12 ... 33 VDC
Input voltage $U_{SC-10}$	11 ... 32 VDC
Transmitter resistance	230 $\Omega$ ...5.5 k $\Omega$
Max. load vs power supply voltage	$R_{max} = (U_s - 11 V) / 23.6 mA$
Current output, nominal	4 ... 20 mA (current sink)
Current output with sensor interruption	3 mA +/- 5% / $\geq 23.5 mA$
Current output without magnet field	3.5 mA +/- 5%
Isolation voltage to housing	500VDC
Reaction time of current output	ca. 50 ms
Reaction time of magnet failure	ca. 600 ms
Reaction time of sensor interruption	ca. 50 ms
Accuracy (input voltage)	< 0.1‰
Accuracy (4 mA adjustment)	< +/- 2‰
Accuracy (transfer characteristic)	< 5‰
Accuracy (temperature coefficient)	< 0.1‰/°C
Sensor current	170 $\mu A$ ... 2.1 mA
Sensor voltage ( $R_{sensor} > 500 \Omega$ )	950 mV
Sensor voltage ( $R_{sensor} < 500 \Omega$ )	475 mV

Dimensions:

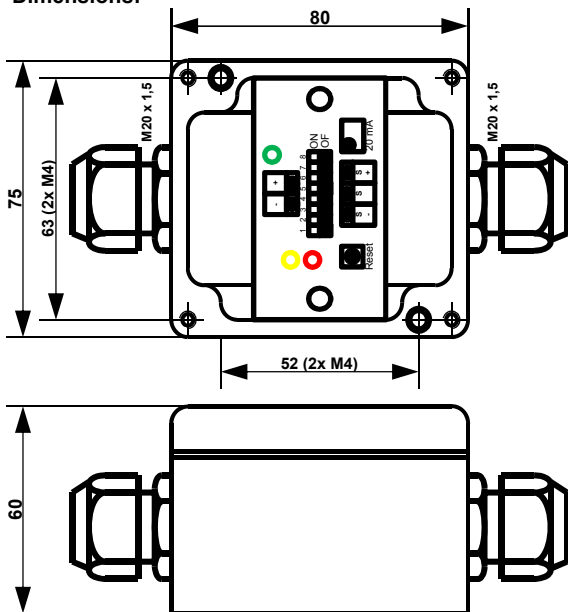

<b>Operating temperature</b>	
Ambient temperature ( $T_a$ )	-20°C ... +50°C
Media temperature	-40°C ... +85°C (at VLI) > 85°C (seperated from VLI)

**Enclosure** IP65 (EN60529)

<b>Materials</b>	
Housing	Aluminium: grey
Cable glands	PA: grey, M20x1.5
- seals	Perbunan (NBR)
- cable compatibility	$\varnothing$ 3 ... 7 mm
Max. cross section of clamps	2.5 mm <sup>2</sup>
Type label	Polyester: silver, black printed



### External electrical connections

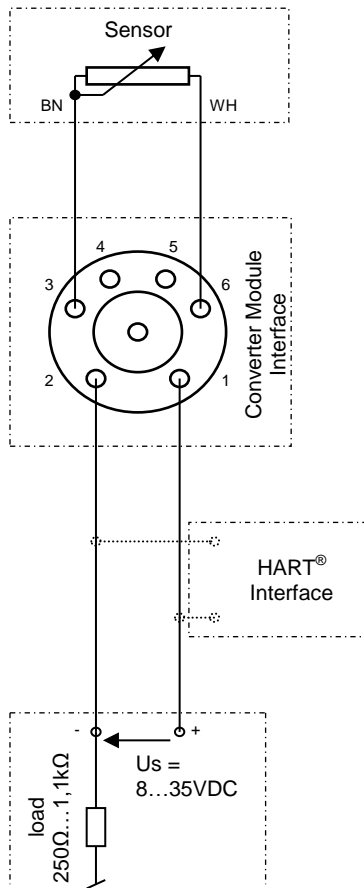

### Dimensions

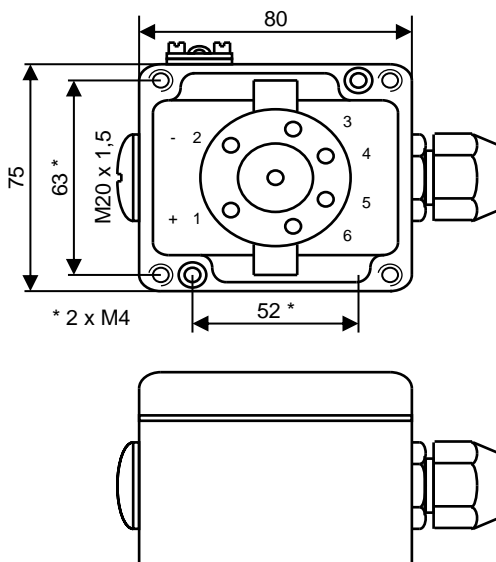

### Description:

**HART® converter module interface with 4...20mA current loop output for use with WEKA Transmitter 29710-R-010-xx and 29710-R-W-010-xx**

The converter module interface attached to the float chamber generates a resistance output proportional to the liquid level inside the chamber. The interface converts this variable resistance into a 2-wire 4...20mA current output with superimposed HART® digital communication. Zero and range setting is done through the HART® communication channel. For high temperature applications, the converter module interface can be installed at a distance (up to 10m) away from the level indicator and transmitter.

### Product code

**37383**

### Resolution

refer to [29710-R-010-xx](#) [29710-R-W-010-xx](#)

### Housing dimensions

80 x 75 x 57mm

### Cable entry

Threaded socket, M20 x 1.5

### Installation

On mounting plate (860528) or at other suitably prepared location using 2 x M4 screws 52 x 63 mm diagonal spacing

### Specifications

Loop supply voltage	8 ... 35VDC
Voltage drop	8VDC
Isolation voltage	Test = 1.5kVAC; operation = 50VAC
Communication	Loop Link 5905 & HART®
Current loop output	4...20mA
Response time	440ms
Transmitter fault output	3.5mA or 23mA (programmable)
Input	0Ω (min.) to 7000Ω (max.)
Minimum span	25Ω
Lead wire resistance	Max. 5Ω
Transmitter current	0.2mA, nominal
Basic accuracy	≤ +/- 0.1%
Temperature coefficient	≤ +/- 5mΩ / °C
Zero offset	Max. 50% of selected span

### Operating temperature

Media temperature	29710-R-010-xx	-50°C ... +150°C
	29710-R-W-010-xx	-50°C ... +350°C
Ambient temperature (Ta)		-30°C ... +50°C
Operating temperature	(mounted on VLI)	-30°C ... +85°C
	(away from VLI)	< -30°C / > +85°C

### Enclosure

IP65 (EN60529)

### Materials

Housing	Aluminium: blue, with grounding terminal
Cable gland	PA: grey, M20x1.5
- Seal	Perbunan (NBR)
- Cable compatibility	Ø 3 ... 7mm; max. 2 x 1mm <sup>2</sup>
Type label	Polyester: silver, black printing

#### External electrical connections

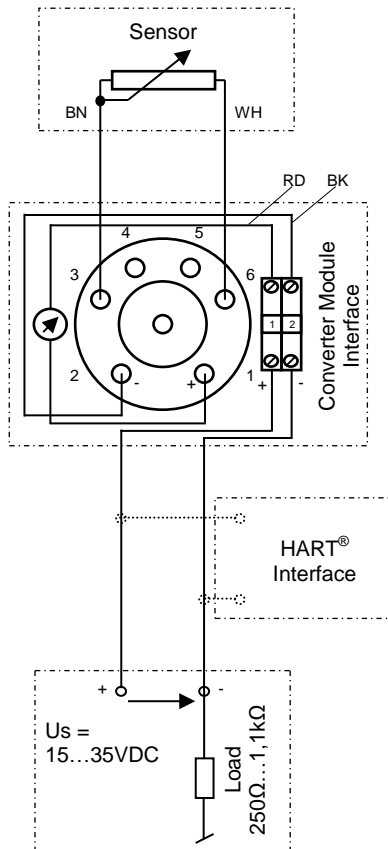

#### Dimensions

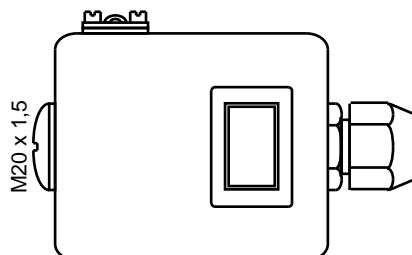
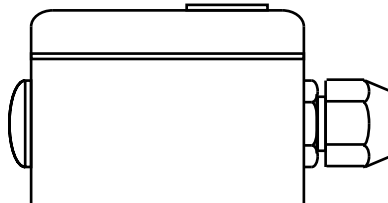
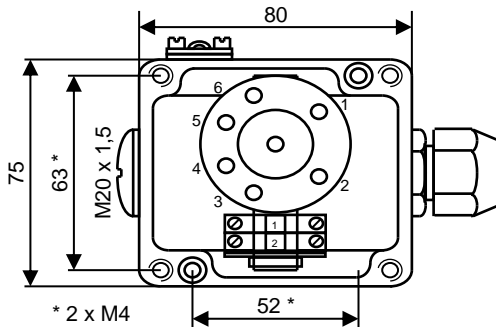

#### Function

**HART® converter module interface with 4...20mA current loop output and digital display for use with WEKA Transmitter 29710-R-010-xx and 29710-R-W-010-xx**

The converter module interface attached to the float chamber generates a resistance output proportional to the liquid level inside the chamber. The interface converts this variable resistance into a 2-wire 4...20mA current output with superimposed HART® digital communication. Zero and range setting is done through the HART® communication channel. For high temperature applications, the converter module interface can be installed at a distance (up to 10m) away from the level indicator and transmitter.

Additionally there is a digital display built in to the terminal box

#### Product code

**40038**

#### Resolution

refer to [29710-R-010-xx](#) [29710-R-W-010-xx](#)

#### Housing dimensions

80 x 75 x 57mm

#### Cable entry

threaded socket M20 x 1,5

#### Installation

On mounting plate (860528) or at other suitably prepared location using 2 x M4 screws 52 x 63 mm diagonal spacing

#### Specifications

Loop supply voltage	15 ... 35VDC
Voltage drop	14VDC
Isolation voltage / operation	1,5kVAC / 50VAC
Communication	Loop Link 5905 & HART®
Current loop output	4 ... 20mA
Digital display	4 digit LCD, display value in % $\pm$ 4...20mA
Response time	440ms
Transmitter fault output	3.5mA or 23mA (programmable)
Input	0 $\Omega$ (min.) to 7000 $\Omega$ (max.)
Minimum span	min. 25 $\Omega$
Lead wire resistance	max. 5 $\Omega$
Transmitter current	0.2mA, nominal
Basic accuracy	$\leq$ +/- 0,1 $\Omega$
Temperature coefficient	$\leq$ +/- 5m $\Omega$ / °C
Zero offset	max. 50% of selected span

#### Operating temperature

Media temperature	29710-R-010-xx	-50°C ... +150°C
	29710-R-W-010-xx	-50°C ... +350°C
Ambient temperature (Ta)		0°C ... +50°C
Operation temperature	(mounted on VLI)	0°C ... +50°C
	(away from VLI)	< 0°C / > +50°C

#### Enclosure

IP65 (EN60529)

#### Materials

Housing	Alu: blue, with grounding terminal
Digital display	Plastic: black
	Display black & green
Cable gland	PA: grey, M20x1,5
- Seal	Perbunan (NBR)
- Cable compatibility	$\varnothing$ 3 ... 7mm, max. 2 x 1mm <sup>2</sup>
Type label	Polyester: silver, black printing

**External electrical connections**

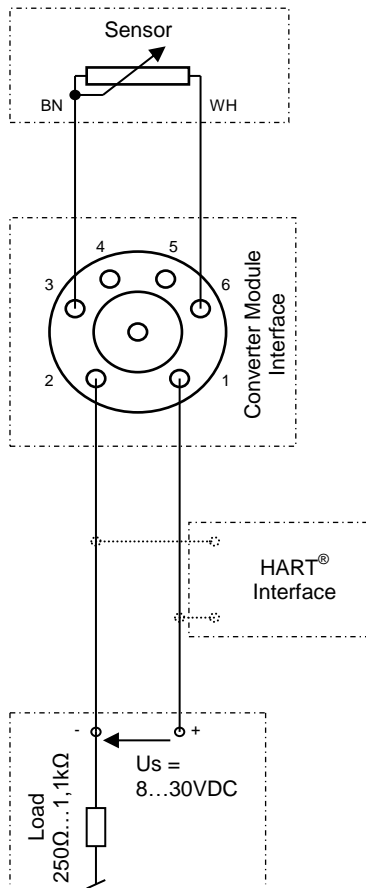

**Dimensions**

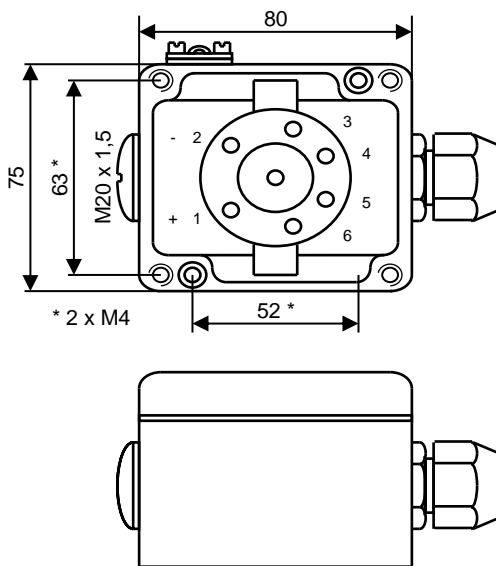

**Description:**

**HART® converter module interface with 4...20mA current loop output, Intrinsically safe for use in zone 1 and 2 and with WEKA Transmitter 29710-R-NI-xx and 29710-R-W-010-xx**

The converter module interface attached to the float chamber generates a resistance output proportional to the liquid level inside the chamber. The interface converts this variable resistance into a 2-wire 4...20mA current output with superimposed HART® digital communication. Zero and range setting is done through the HART® communication channel. For high temperature applications, the converter module interface can be installed at a distance (up to 10m) away from the level indicator and transmitter.

**Product code**

**37384**

**Resolution**

refer to [29710-R-NI-xx](#) [29710-R-W-010-xx](#)

**Housing dimensions**

80 x 75 x 57mm

**Cable entry**

Threaded socket, M20 x 1.5

**Installation**

On mounting plate (860528) or at other suitably prepared location using 2 x M4 screws 52 x 63 mm diagonal spacing

**Specifications**

Loop supply voltage	8 ... 30VDC
Voltage drop	8VDC
Isolation voltage	Test = 1.5kVAC; operation = 50VAC
Communication	Loop Link 5905 & HART®
Current loop output	4 - 20mA
Response time	440ms
Transmitter fault output	3.5mA or 23mA (programmable)
Input	0Ω (min.) to 7000Ω (max.)
Minimum span	25Ω
Lead wire resistance	Max. 5Ω
Transmitter current	0.2mA, nominal
Basic accuracy	≤ +/- 0,1Ω
Temperature coefficient	≤ +/- 5mΩ / °C
Zero offset	Max. 50% of selected span

**Operating temperature**

Media temperature	29710-R-NI-xx	-50°C ... +150°C
	29710-R-W-010-xx	-50°C ... +350°C
Ambient temperature (Ta)	for T1, T2, T3, T4	-30°C ... +85°C
	for T5, T6	-30°C ... +60°C
Operating temperature	(mounted on VLI)	-30°C ... +85°C
	(away from VLI)	< -30°C / > +85°C

**Enclosure**

IP65 (EN60529)

**Materials**

Housing	Alu: blue, with grounding terminal
Cable gland	PA: blue; M20x1.5
- Seal	Perbunan (NBR)
- Cable compatibility	Ø 6 ... 8mm; max. 2 x 1mm <sup>2</sup>

CE 0344  II 1 G Ex ia IIC T4 or T6  
 II 1 D Ex iaD KEMA 03 ATEX 1537

**Electrical limit values**

Ui =	max. 30VDC
Ii =	max. 120mA
Pi =	max. 840mW
Ci =	≤ 1nF
Li =	≤ 10μH



**IECEX KEM 10.0083X issue 3**

**External electrical connections**

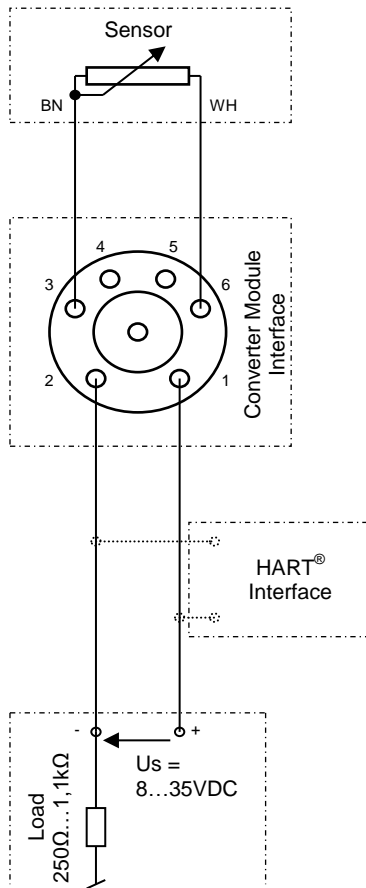

**Dimensions**

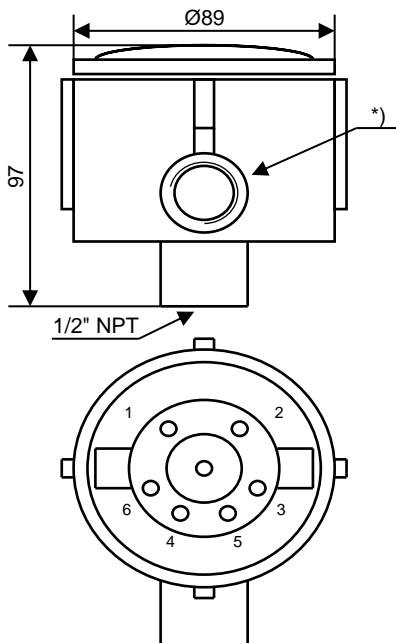

IECEx KEM 10.0083X issue 3

**Description:**

**HART® converter module interface with 4...20mA current loop output, Flameproof enclosures for use in zone 1 and 2 and with WEKA Transmitter 29710-R-ND-xx**

The converter module interface attached to the float chamber generates a resistance output proportional to the liquid level inside the chamber. The interface converts this variable resistance into a 2-wire 4...20mA current output with superimposed HART® digital communication. Zero and range setting is done through the HART® communication channel. For high temperature applications, the converter module interface can be installed at a distance (up to 10m) away from the level indicator and transmitter.

**Product code** 38021

**Resolution** refer to [29710-R-ND-xx](#)

**Housing dimensions** Ø ~ 130mm x 97mm (height)

**Cable entry \*)** Threaded socket, M20 x 1.5 or 1/2"NPT

**Installation** Mounted on the level indicator (or at other suitably prepared location) using a hose clamp (84242) and coupling (20000710).

**Specifications**

Loop supply voltage	8 ... 35VDC
Voltage drop	8VDC
Isolation voltage	Test = 1.5kVAC; operation = 50VAC
Communication	Loop Link 5905 & HART®
Current loop output	4 - 20mA
Response time	440ms
Transmitter fault output	3.5mA or 23mA (programmable)
Input	0Ω (min.) to 7000Ω (max.)
Minimum span	25Ω
Lead wire resistance	Max. 5Ω
Transmitter current	0.2mA, nominal
Basic accuracy	≤ +/- 0,1%
Temperature coefficient	≤ +/- 5mΩ / °C
Zero offset	Max. 50% of selected span

**Operating temperature**

Media temperature	29710-R-ND-xx	-50°C ... +150°C
Ambient temperature (Ta)		-30°C ... +50°C
Operating temperature	(mounted on VLI)	-30°C ... +85°C
	(away from VLI)	< -30°C / > +85°C

**Enclosure**

IP68 - 10bar (EN60529)

**Materials**

Housing	Alu: grey, Ex d
Cable gland	Brass: nickel plated, PTB 00 ATEX 1059
- Seal	Perbunan (NBR)
- Cable compatibility	Ø ~ 7 ... 9mm; max. 2 x 1mm <sup>2</sup>
Type label	Polyester: silver, black printing

**Housing:**

CE 0722 Ex II 2GD Ex d IIC CESI 03 ATEX 059U

**Converter:**

II 3 GD Ex nA[nL] IIC T4...T6 or  
 II 3 GD Ex nL IIC T4...T6 or  
 CE 0344 Ex II 3 GD Ex nA[ic] IIC T4...T6 or  
 II 3 GD Ex ic IIC T4...T6  
**KEMA 03 ATEX 1508 X**

External electrical connections

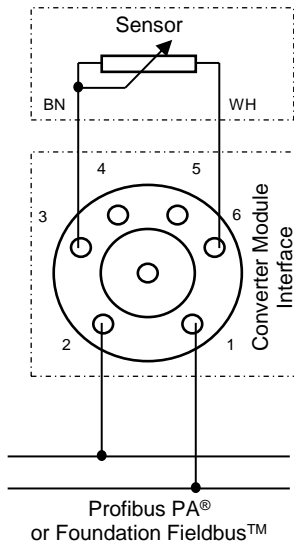

Description:

Profibus PA® or Foundation Fieldbus™ converter module Interface for use with WEKA Transmitter 29710-R-010-xx and 29710-R-W-010-xx

The converter module interface attached to the float chamber generates a resistance output proportional to the liquid level inside the chamber. The interface converts this variable resistance into a 2-wire digital current output with Profibus PA® or Foundation Fieldbus™ communication. The converter switches automatically between the 2 protocols. Zero and range setting is done through the digital communication channel. For high temperature applications, the converter module interface can be installed at a distance (up to 10m) away from the level indicator and transmitter.

**Product code** 40268

**Resolution** refer to [29710-R-010-xx](#) [29710-R-W-010-xx](#)

**Housing dimensions** 80 x 75 x 57mm

**Cable entry** Threaded socket, M20 x 1.5

**Installation** On mounting plate (860528) or at other suitably prepared location, using 2 x M4 screws 52 x 63 mm diagonal spacing

Dimensions

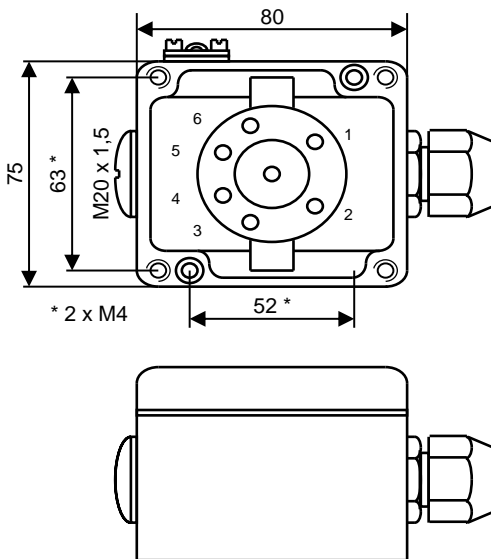

Specifications

Loop supply voltage	9 to 30VDC
Consumption	< 11mA
Isolation voltage	test = 1.5kVAC; operation = 50VAC
Communication	PROFIBUS™ PA / FOUNDATION™ Fieldbus
Response time	1 ... 60s
Sensor error detection	Yes
Short circuit detection	< 15Ω
Input	0Ω (min.) to 10'000Ω (max.)
Cable resistance per wire	50Ω
Transmitter current	0.2mA, nominal
Basic accuracy	≤ +/- 0,05Ω
Temperature coefficient	≤ +/- 2mΩ / °C

Operating temperature

Media temperature	29710-R-010-xx	-50°C ... +150°C
	29710-R-W-010-xx	-50°C ... +350°C
Ambient temperature (Ta)		-30°C ... +50°C
Operating temperature	(mounted on VLI)	-30°C ... +85°C
	(away from VLI)	< -30°C / > +85°C

Enclosure

IP65 (EN60529)

Materials

Housing	Alu: blue, with grounding terminal
Cable gland	PA: grey, M20x1.5
- Seal	Perbunan (NBR)
- Cable compatibility	Ø 3 ... 7mm; max. 2 x 1mm <sup>2</sup>
Type label	Polyester: silver, black printing

Note

- A unique switch function ensures the automatic shift between the Profibus PA® and the Foundation Fieldbus™ protocols.
- Profibus PA® Version 3.0 or Foundation Fieldbus™ Version ITK 4.51 is applied.
- Set-up for Profibus PA® can be done via Siemens Simatic® PDM®, ABB Melody/Harmony, Honeywell Ax and Metso DNA software
- Set-up for Foundation Fieldbus™ can be done via Emerson Delta V, Yokogawa CS 1000/CS 3000, ABB Melody/Harmony and Honeywell Psource software.
- Polarity-independent bus connection
- Profibus PA™ function blocks: 2 analogue
- Foundation Fieldbus™ function blocks: 2 analogue and 1 PID
- Foundation Fieldbus™ capability: BASIC or LAS



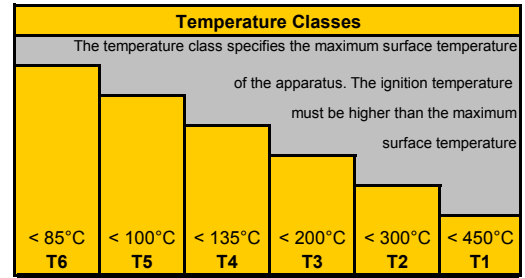

Classification and Marking of Flameproof enclosures Apparatus				
Inflammable Material	Incidence of inflammable material in Ex zone. Explosive media	Hazardous zones	Marking of Flameproof enclosures equipment	
			Apparatus group	Apparatus category
Gases Vapor Steam	Present continuously, frequently, or over extended periods of time	Zone 0	II	
	Present occasionally	Zone 1	II	1G, 2G, 3G
	Presence unlikely or rare and only for brief periods of time	Zone 2	II	
Inflamm-able dust cloud	Present continuously, frequently, or over extended periods of time	Zone 20	II	
	Present occasionally	Zone 21	II	1D, 2D, 3D
	Presence unlikely or rare, and only for brief periods of time	Zone 22	II	
Methane	-	Mines	I	M1, M2
	-	Mines	I	

Classification of Gases, Aerosols, Vapors				
Apparatus Group	Examples of inflammable Gases			
[Note: This is only a partial list of inflammable gases/vapors]				
IIA IIIA	Ammonia, Methane, Ethane, Propane	Ethyl alcohol, Cyclohexane, N-butane	Benzene, Diesel, Furnace oil, N-hexane	Acetaldehyde
IIB IIIB	Town gas, Acrylonitrile	Ethylene, Ethylene oxide	Ethyl glycol, Hydrogen sulfide	Ethyl ether
IIC IIIC	Hydrogen	Acetylene		Carbon disulfide



Example:

1258

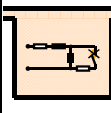
II 2G Ex d IIC T6 SEV 17 ATEX0168 -

Authority	Methods of Protection and Apparatus Marking						Certificate	Additional information	
Certificate reference number	An explosion inside the enclosure is prevented from spreading outside	Flameproof enclosures	Ex d		Zone 1 or 2	IEC EN 60079-1 (Gas) IEC EN 60079-31 (Dust)	ATEX marking and certificate number	The equipment may be used without restriction	-
	The energy in the electrical circuit in the hazardous zone is limited by design, thus preventing dangerous sparks and/or ignition temperatures	Intrinsically safe	Ex i		Zones 0, 1 and 2: Ex ia Zones 1 and 2: Ex ib	IEC EN 60079-11	Year of certification	The equipment may be used subject to specific conditions	X
	Principle of protection [All methods of ignition protection are not indicated here, for simplification]	Means of protection	Marking [Omitted here: Ex o, Ex p, Ex q, Ex e, Ex m, Ex n]	Symbol	Zone compatibility	Standard	Abbreviated name of certification authority (notified body)	The equipment is an "Ex" component with part-certification and therefore cannot be used as standalone.	U
						Traceability reference	Conditions	Marking	

**Note:**

- Per ATEX guidelines, WEKA Level Indicators and accessories are **components only**, as they function only together with other equipment.
- An electrical device can be used in a temperature class lower than its certification, if operating conditions allow this.
- "Ex" components and attached metallic equipment must be connected to a common electrical ground point.

## EN 60079-11:2012

### 5.7 Simple apparatus

The following apparatus shall be considered to be simple apparatus

- a) passive components, for example switches, junction boxes, resistors and simple semiconductor devices;
- b) sources of stored energy consisting of single components in simple circuits with well- defined parameters, for example capacitors or inductors, whose values shall be considered when determining the overall safety of the system;
- c) sources of generated energy, for example thermocouples and photocells, which do not generate more than 1,5V, 100mA and 25mW.

Simple apparatus shall conform to all relevant requirements of this standard. The manufacturer or intrinsically safe system designer shall demonstrate compliance with this clause, including material data sheets and test reports, if applicable. The apparatus need not comply with Clause 12.

The following aspects shall always be considered:

- 1) simple apparatus shall not achieve safety by the inclusion of voltage and/or current- limiting and/or suppression devices;
- 2) simple apparatus shall not contain any means of increasing the available voltage or current, for example DC-DC converters;
- 3) where it is necessary that the simple apparatus maintains the integrity of the isolation from earth of the intrinsically safe circuit, it shall be capable of withstanding the test voltage to earth in accordance with 6.3.12. Its terminals shall conform to 6.2.1;
- 4) non-metallic enclosures and enclosures containing light metals when located in the explosive gas atmosphere shall conform to 7.3 and 8.1 of IEC 60079-0;
- 5) when simple apparatus is located in the explosive gas atmosphere, it shall be temperature classified. When used in an intrinsically safe circuit within their normal rating and at a maximum ambient temperature of 40°C, switches, plugs, sockets and terminals will have a maximum surface temperature of less than 85°C, so they can be allocated a T6 temperature classification for Group II applications and are also suitable for Group I applications. Other types of simple apparatus shall be temperature classified in accordance with Clause 4 of this standard.

Where simple apparatus forms part of an apparatus containing other electrical circuits, the whole shall be assessed according to the requirements of this standard.

#### NOTE 1

Sensors which utilize catalytic reaction or other electro-chemical mechanisms are not normally simple apparatus. Specialist advice on their application should be sought.

#### NOTE 2

It is not a requirement of this standard that the conformity of the manufacturer's specification of the simple apparatus needs to be verified.